

ASSR-V621 and ASSR-V622

Dual Channel Photovoltaic MOSFET Driver

(6.5V/15 μ A)



Data Sheet



Description

The ASSR-V62X Series is specially designed to drive high power MOSFETs. It consists of an AlGaAs infrared light-emitting diode (LED) input stage optically coupled to an output detector circuit. The detector consists of a high-speed photovoltaic diode array and driver circuitry to switch on/off two discrete high voltage MOSFETs externally. The relay driver turns on (contact closes) with a minimum input current of 3mA through the input LED. The relay driver turns off (contact opens) with an input voltage of 0.8V or less.

The dual channel configurations, ASSR-V621 and ASSR-V622, allow 2 independent MOSFETs to be driven. It has the versatility to double the photovoltaic voltage by connecting the 2 channels in series or to double the short circuit current by connecting the 2 channels in parallel. They are available in 8-pin DIP and Gull Wing Surface Mount packages.

Features

- Dual Channel Photovoltaic MOSFET Driver
- Open Circuit Voltage: 7V Typical
- Short Circuit Current: 20 μ A Typical
- Low Input Current: CMOS Compatibility
- Fast Switching Speed:
0.3ms (Ton), 0.03ms (Toff) Typical
- High Input-to-Output Insulation Voltage (Safety and Regulatory Pending Approvals)
 - 3750 Vrms for 1 min per UL1577
 - CSA Component Acceptance

Applications

- Solid State Relay Module
- Voltage Supply for electronic circuits

CAUTION: It is advised that normal static precautions be taken in handling and assembly of this component to prevent damage and/or degradation which may be induced by ESD.

Ordering Information

ASSR-xxxx is UL Recognized with 3750 Vrms for 1 minute per UL1577 and is approved under CSA Component Acceptance Notice #5, File CA 88324.

Part number	Option	Package	Surface Mount	Gull Wing	Tape & Reel	Quantity
	RoHS Compliant					
ASSR-V621	-002E	300 mil DIP-8	X	X		50 units per tube
	-302E					50 units per tube
	-502E					1000 units per reel
ASSR-V622	-002E	300 mil DIP-8	X	X		50 units per tube
	-302E					50 units per tube
	-502E					1000 units per reel

To order, choose a part number from the part number column and combine with the desired option from the option column to form an order entry.

Example:

ASSR-V621-002E to order product of 300mil DIP-8 package in tube packaging and RoHS Compliant.

Option datasheets are available. Contact your Avago sales representative or authorized distributor for information.

Schematic

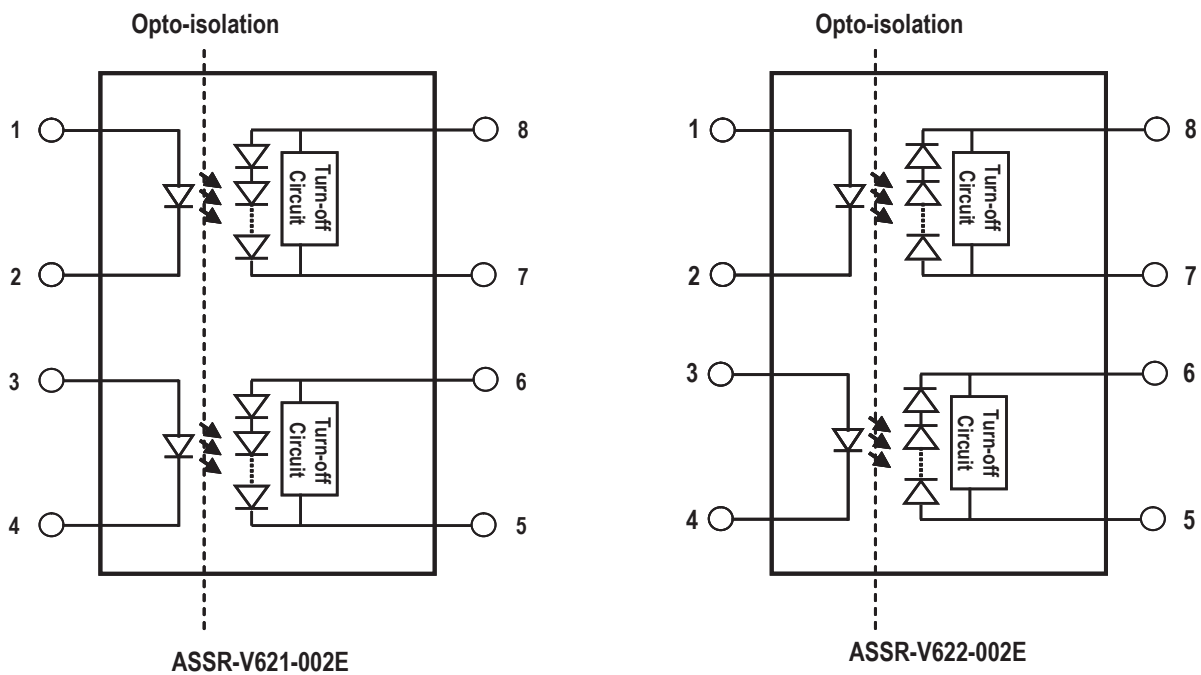

Package Outline Drawings

8-Pin DIP Package

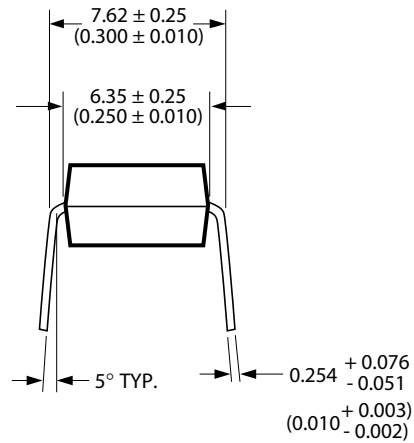
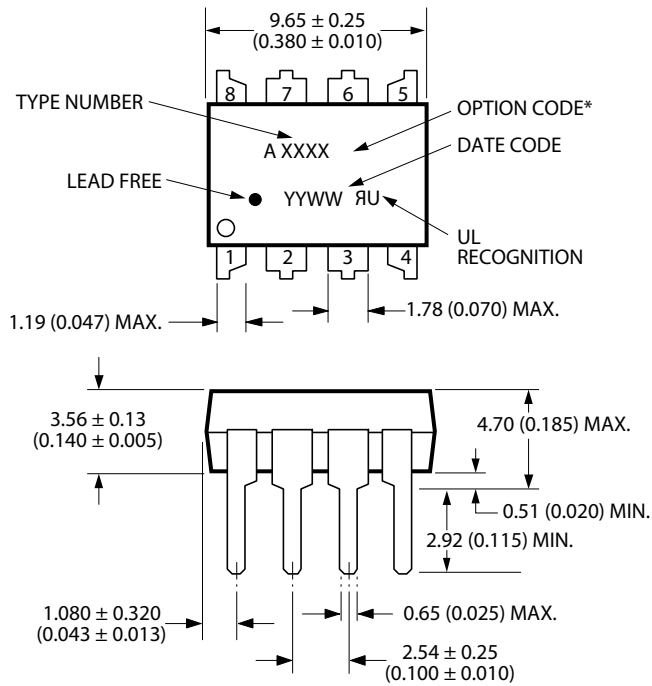

DIMENSIONS IN MILLIMETERS AND (INCHES).
OPTION NUMBERS 300 AND 500 NOT MARKED.

8-Pin DIP Package with Gull Wing Surface Mount Option 300

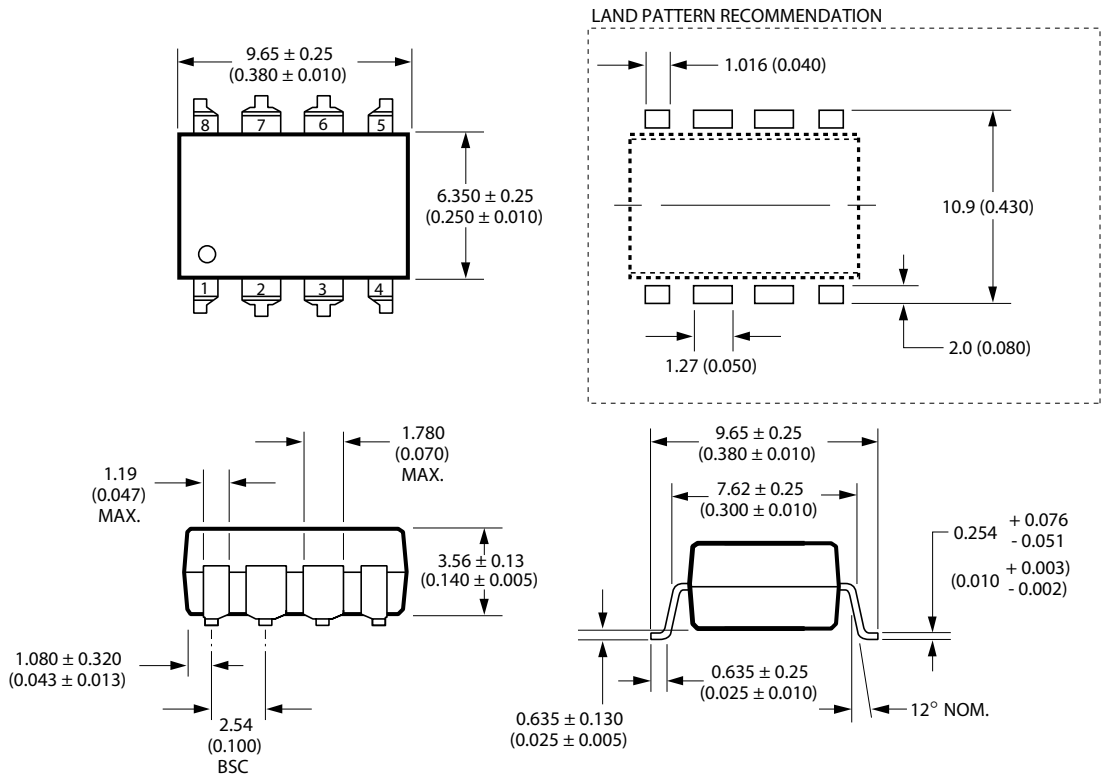

DIMENSIONS IN MILLIMETERS (INCHES).
LEAD COPLANARITY = 0.10 mm (0.004 INCHES).

NOTE: FLOATING LEAD PROTRUSION IS 0.25 mm (10 mils) MAX.

Lead Free IR Profile

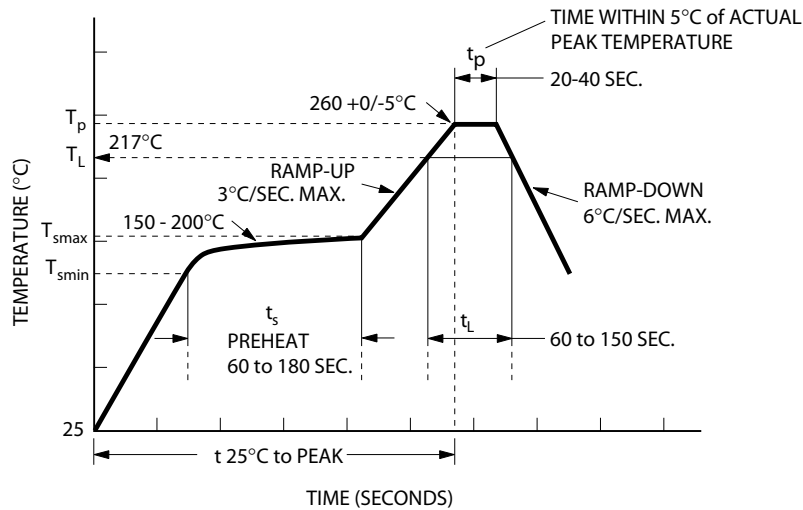

Use of non-chlorine-activated fluxes is highly recommended.

Note: Non-Halide flux should be used.

Regulatory Information

The ASSR-V621-002E and ASSR-V622-002E are approved by the following organizations:

UL

Approved under UL 1577, component recognition program up to $V_{ISO} = 3750 V_{RMS}$

Approved under CSA Component Acceptance Notice #5.

Insulation and Safety Related Specifications

Parameter	Symbol	ASSR-V621-002E	Units	Conditions
		ASSR-V622-002E		
Minimum External Air Gap (Clearance)	L(101)	7.1	mm	Measured from input terminals to output terminals, shortest distance through air.
Minimum External Tracking (Creepage)	L(102)	7.4	mm	Measured from input terminals to output terminals, shortest distance path along body.
Minimum Internal Plastic Gap (Internal Clearance)		0.08	mm	Through insulation distance conductor to conductor, usually the straight line distance thickness between the emitter and detector.
Tracking Resistance (Comparative Tracking Index)	CTI	175	V	DIN IEC 112/VDE 0303 Part 1
Isolation Group (DIN VDE0109)		IIIa		Material Group (DIN VDE 0109)

Absolute Maximum Ratings

Parameter	Symbol	Min.	Max.	Units	Note
Storage Temperature	T_S	-55	125	°C	
Operating Temperature	T_A	-40	85	°C	
Lead Soldering Cycle	Temperature		260	°C	
	Time		10	s	
Input Current	Average	I_F	30	mA	
	Surge		300		
	Transient		1000		
Reversed Input Voltage	V_R		5	V	
Input Power Dissipation	P_{IN}		100	mW	
Solder Reflow Temperature Profile	See Lead Free IR Profile				

Recommended Operating Conditions

Parameter	Symbol	Min.	Max.	Units	Note
Input Current (ON)	$I_{F(ON)}$	3	30	mA	
Input Voltage (OFF)	$V_{F(OFF)}$	0	0.8	V	
Operating Temperature	T_A	-40	+85	°C	

Package Characteristics

Unless otherwise specified, operating temperature $T_A = 25^\circ\text{C}$.

Parameter	Symbol	Min.	Typ.	Max.	Units	Conditions	Fig.	Note
Input-Output Momentary Withstand Voltage	V_{ISO}	3750			Vrms	$RH \leq 50\%$, $t = 1 \text{ min}$		1
Input-Output Resistance	R_{I-O}		10^{12}		Ω	$V_{I-O} = 500 \text{ Vdc}$		
Input-Output Capacitance	C_{I-O}		0.6		pF	$f = 1 \text{ MHz}$; $V_{I-O} = 0 \text{ Vdc}$		

Electrical Specifications (DC)

For operating $T_A = +25^\circ\text{C}$

Parameter	Symbol	Min.	Typ.	Max.	Units	Conditions	Fig.	Note
Open Circuit Voltage	V_{OC}	6.5	7		V	$I_F = 10\text{mA}$, $I_O = 0\text{mA}$		
Short Circuit Current	I_{SC}	15	20		μA	$I_F = 10\text{mA}$, $V_O = 0\text{V}$		
Input Reverse Breakdown Voltage	V_R	5			V	$I_R = 10\mu\text{A}$		
Input Forward Voltage	V_F	1.1	1.3	1.7	V	$I_F = 10\text{mA}$		

Switching Specifications (AC)

For operating $T_A = +25^\circ\text{C}$

Parameter	Symbol	Min.	Typ.	Max.	Units	Conditions	Fig.	Note
Turn On Time	T_{ON}		0.28		ms	$I_F = 10\text{mA}$, $C_L = 1\text{nF}$		
Turn Off Time	T_{OFF}		0.03		ms	$I_F = 10\text{mA}$, $C_L = 1\text{nF}$		

Note:

1. Device is considered as a two terminal device; pin 1, 2, 3, 4 shorted and pin 5, 6, 7, 8 shorted.

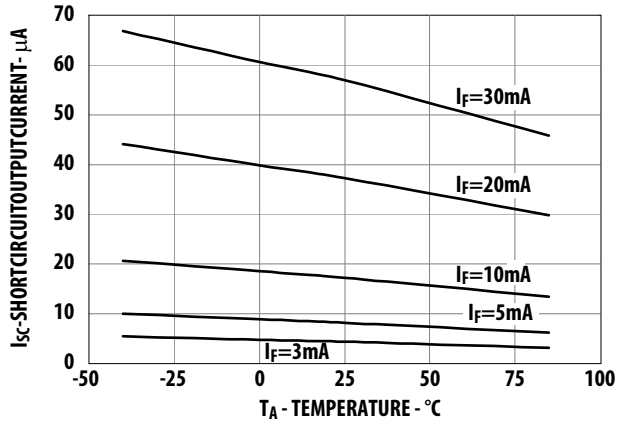

Figure 1. Short Circuit Output Current vs

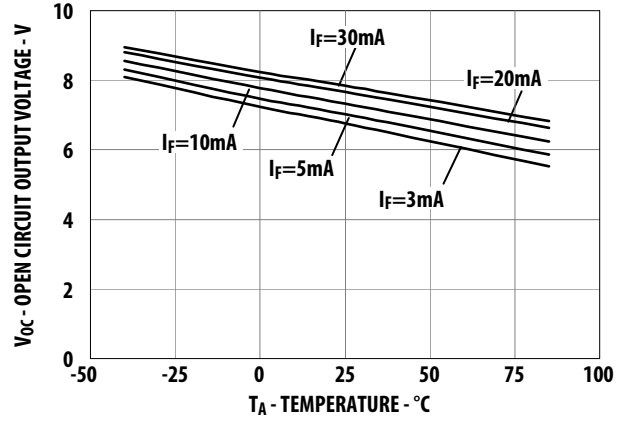

Figure 2. V_{OC} vs Temperature

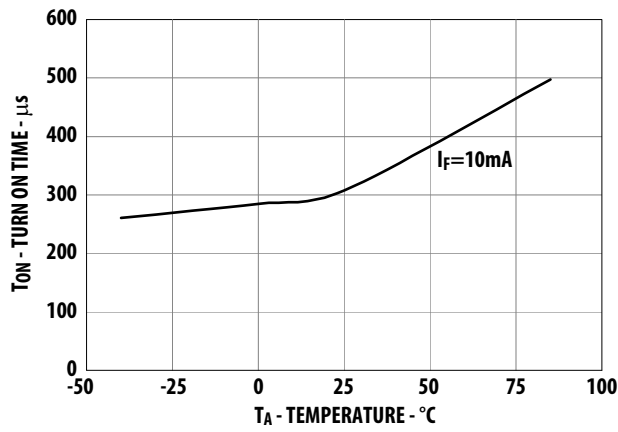

Figure 3. T_{ON} vs Temperature

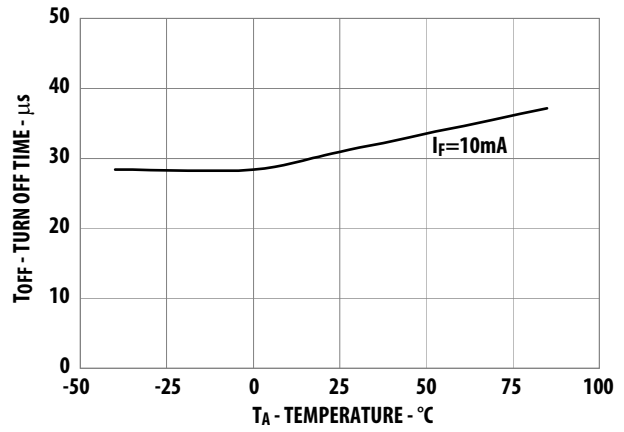

Figure 4. T_{OFF} vs Temperature

For product information and a complete list of distributors, please go to our web site: www.avagotech.com

Avago, Avago Technologies, and the A logo are trademarks of Avago Technologies in the United States and other countries. Data subject to change. Copyright © 2005-2008 Avago Technologies. All rights reserved. AV02-0259EN - July 18, 2008

AVAGO
TECHNOLOGIES