

2SJ55, 2SJ56

HITACHI/(OPTOELECTRONICS)

SILICON P-CHANNEL MOS FET

LOW FREQUENCY POWER AMPLIFIER
Complementary Pair with 2SK175, 2SK176

FEATURES

- High Power Gain.
- Excellent Frequency Response.
- High Speed Switching.
- Wide Area of Safe Operation.
- Enhancement-Mode.
- Good Complementary Characteristics.
- Equipped with Gate Protection Diodes.

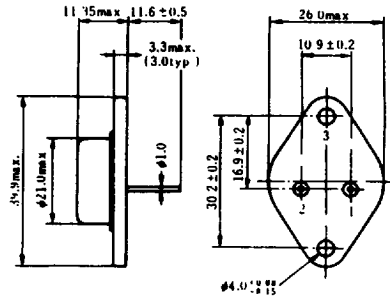
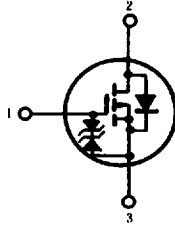

(JEDEC TO-3)

1. Gate
2. Drain
3. Source (Case)

(Dimensions in mm)

ABSOLUTE MAXIMUM RATINGS ($T_a=25^\circ\text{C}$)

Item	Symbol	Rating		Unit
		2SJ55	2SJ56	
Drain-Source Voltage	V_{DSX}	-180	-200	V
Gate-Source Voltage	V_{GSS}	±20		V
Drain Current	I_D	-8		A
Body-Drain Diode Reverse Drain Current	I_{DR}	-8		A
Channel Dissipation	P_{ch} *	125		W
Channel Temperature	T_{ch}	150		°C
Storage Temperature	T_{stg}	-55 ~ +150		°C

*Value at $T_c=25^\circ\text{C}$

POWER VS. TEMPERATURE DERATING

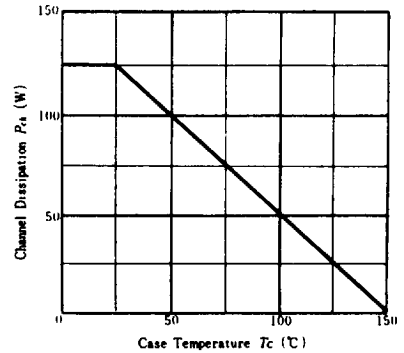

ELECTRICAL CHARACTERISTICS ($T_a=25^\circ\text{C}$)

Item	Symbol	Test Condition	min.	typ.	max.	Unit
Drain-Source Breakdown Voltage	2SJ55	$I_D=-10\text{mA}, V_{GS}=10\text{V}$	-180	—	—	V
	2SJ56		-200	—	—	V
Gate-Source Breakdown Voltage	$V_{(BR)GSS}$	$I_G=\pm 100\mu\text{A}, V_{DS}=0$	±20	—	—	V
Gate-Source Cutoff Voltage	V_{GSOFF}	$I_D=-100\text{mA}, V_{DS}=-10\text{V}$	-0.15	—	-1.45	V
Drain-Source Saturation Voltage	$V_{DS(sat)}$	$I_D=-8\text{A}, V_{GS}=0^*$	—	—	-12	V
Forward Transfer Admittance	$ y_f $	$I_D=-3\text{A}, V_{DS}=-10\text{V}^*$	0.7	1.0	1.4	S
Input Capacitance	C_{iss}	$V_{GS}=5\text{V}, V_{DS}=-10\text{V}, f=1\text{MHz}$	—	1000	—	pF
Output Capacitance	C_{oss}		—	470	—	pF
Reverse Transfer Capacitance	C_{rss}		—	50	—	pF
Turn-on Time	t_{on}	$V_{DD}=-30\text{V}, I_D=-4\text{A}$	—	320	—	ns
Turn-off Time	t_{off}		—	120	—	ns

*Pulse Test

MAXIMUM SAFE OPERATION AREA

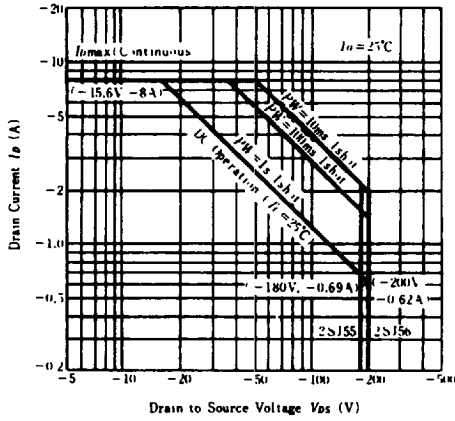

TYPICAL OUTPUT CHARACTERISTICS

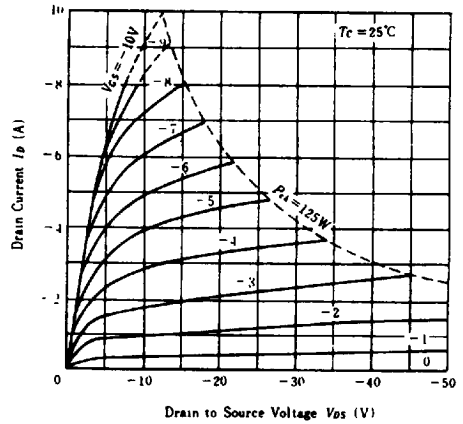

TYPICAL OUTPUT CHARACTERISTICS

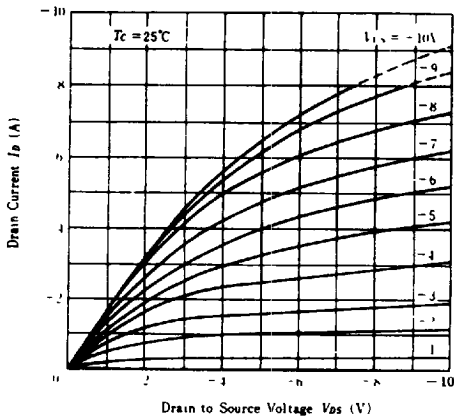

TYPICAL TRANSFER CHARACTERISTICS

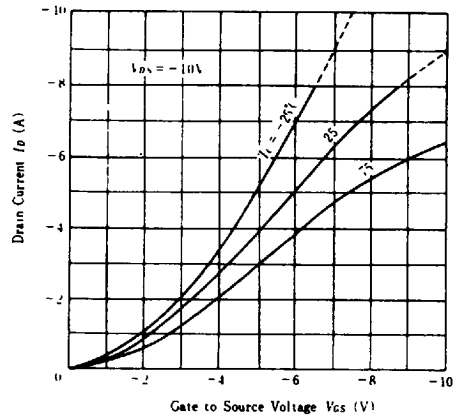

TYPICAL TRANSFER CHARACTERISTICS

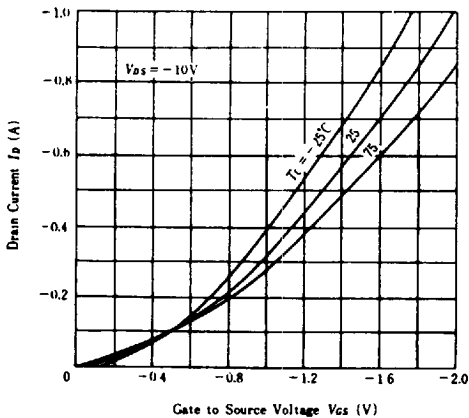

FORWARD TRANSFER ADMITTANCE VS. FREQUENCY

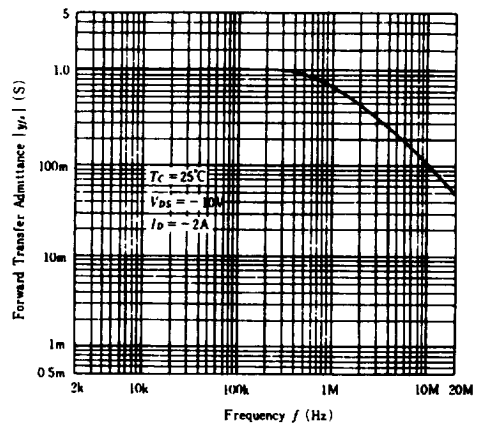

SWITCHING TIME VS. DRAIN CURRENT

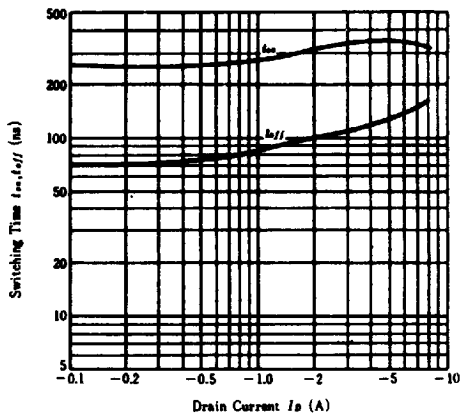

SWITCHING TIME TEST CIRCUIT

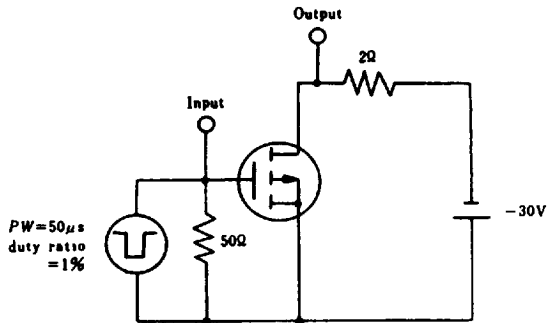

WAVEFORMS

