

A: v2_2

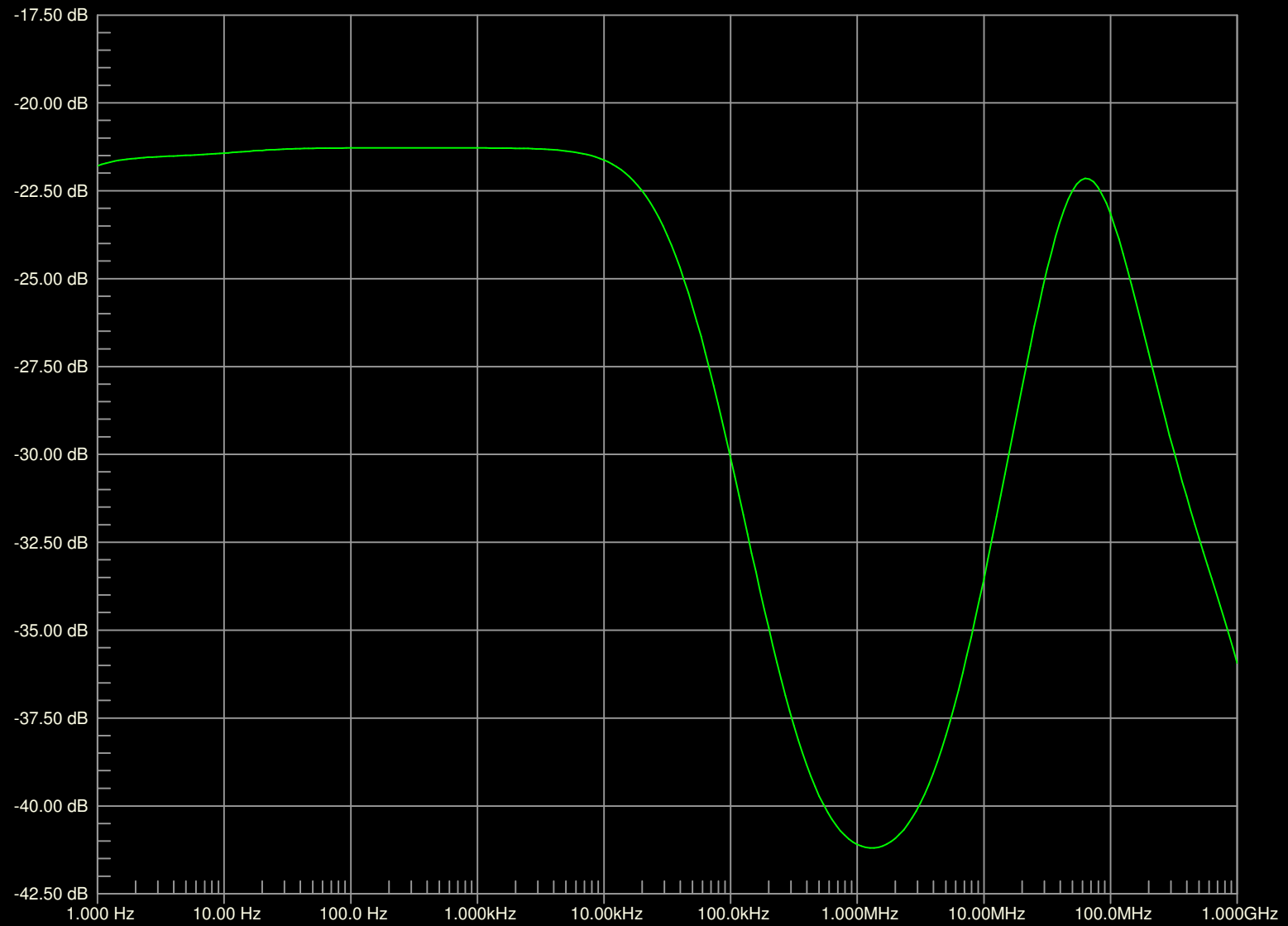

A: d1_a

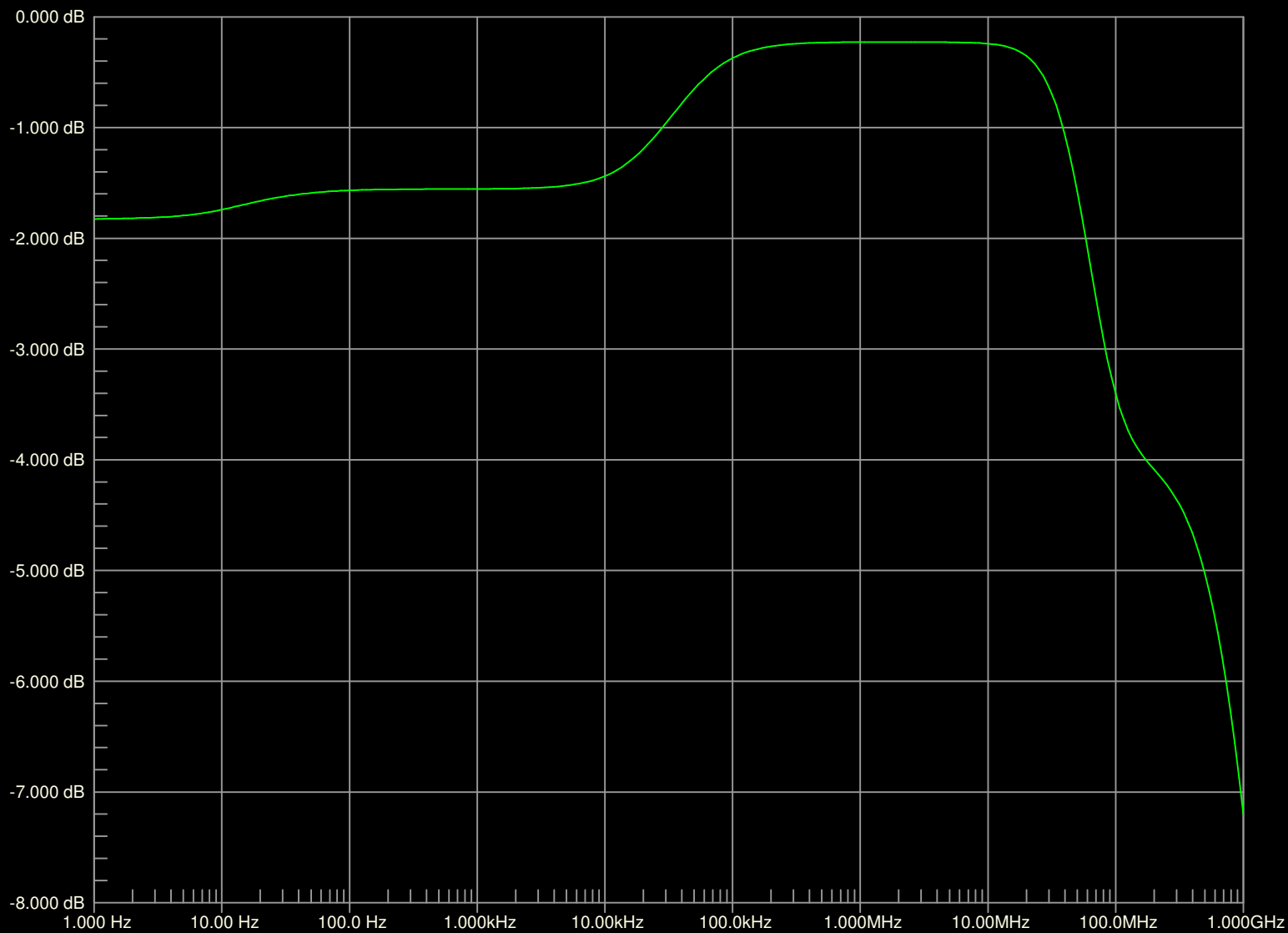

A: d1_a

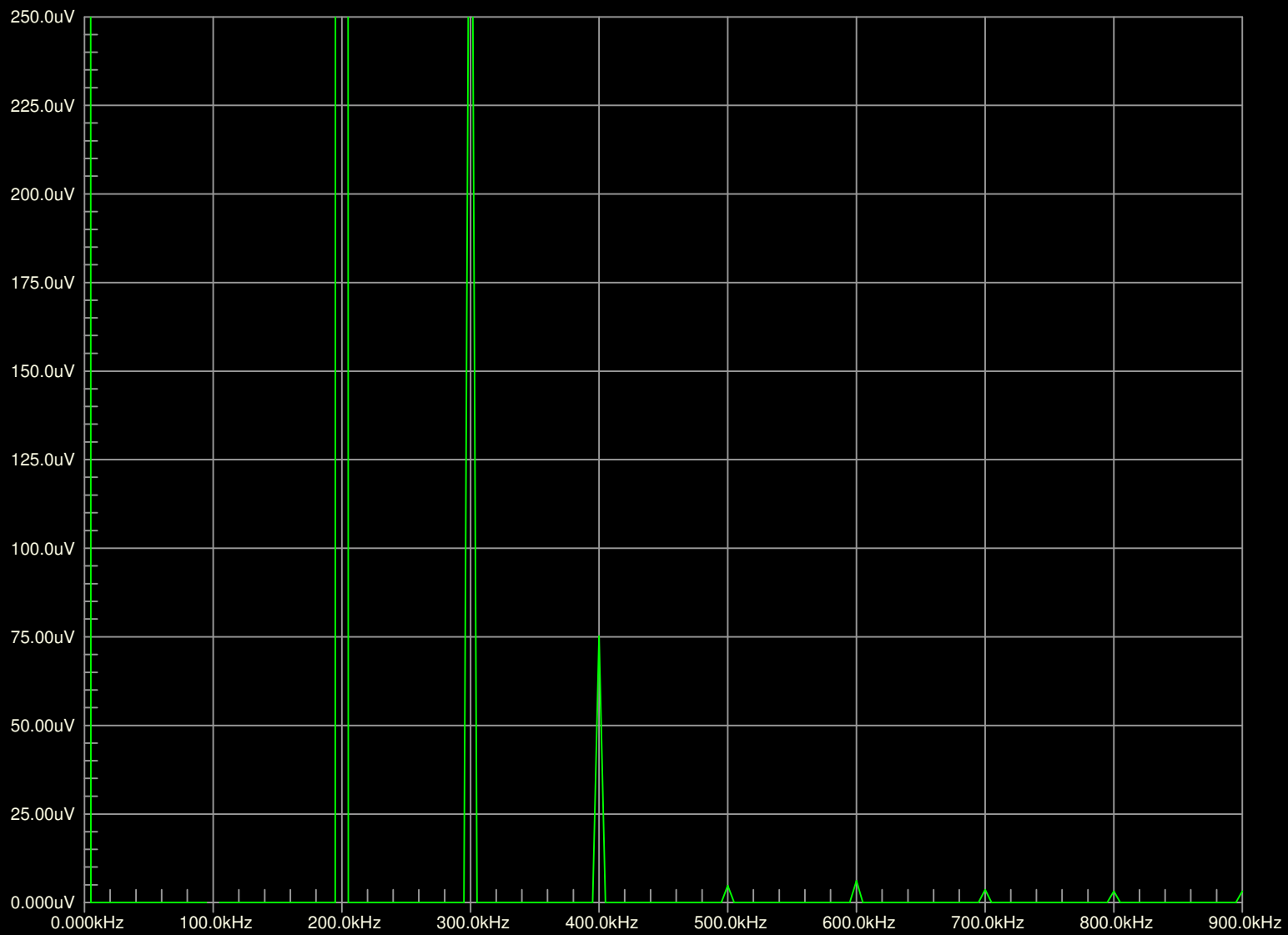

A: d1_a

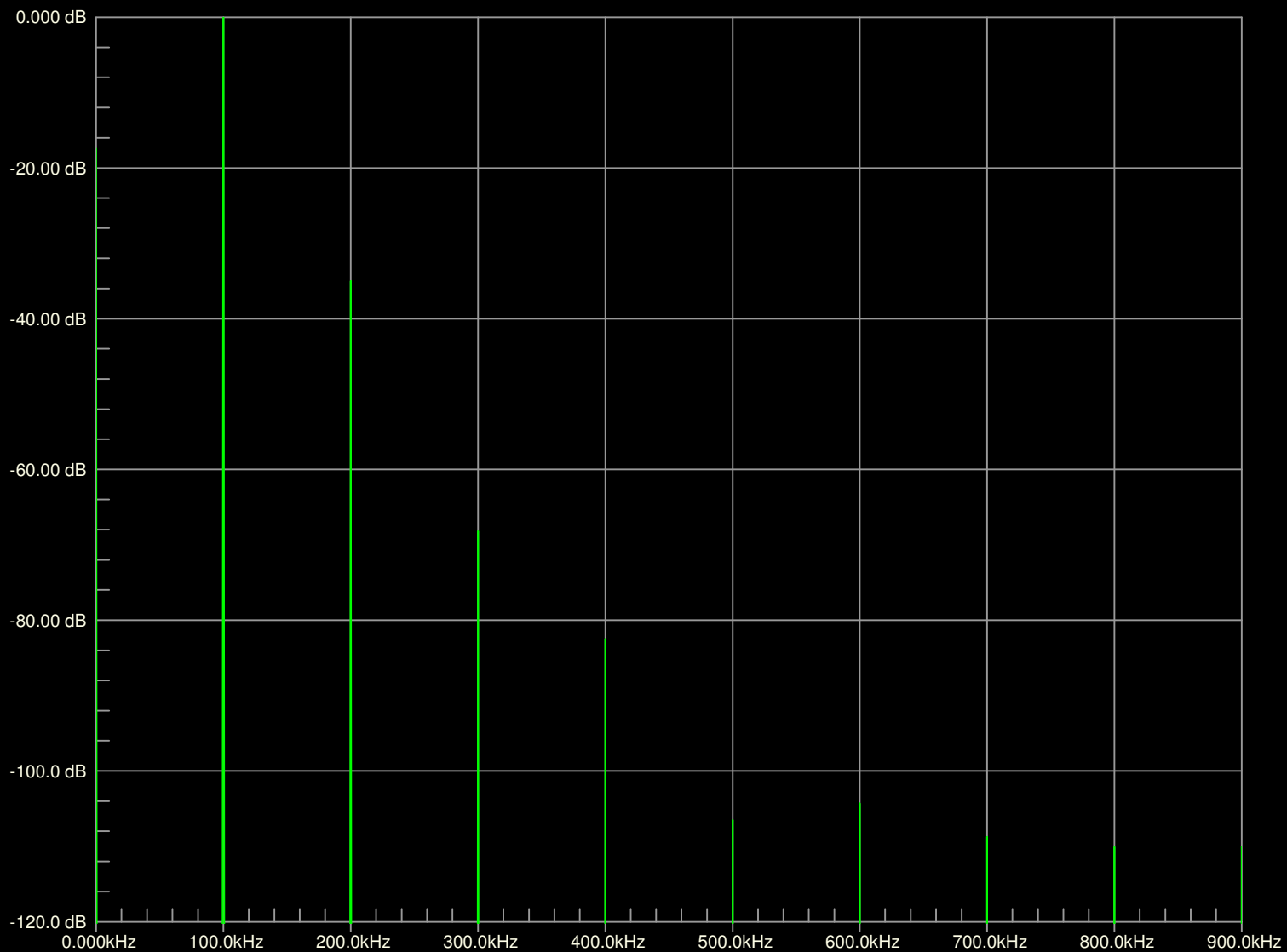

A: d1_a

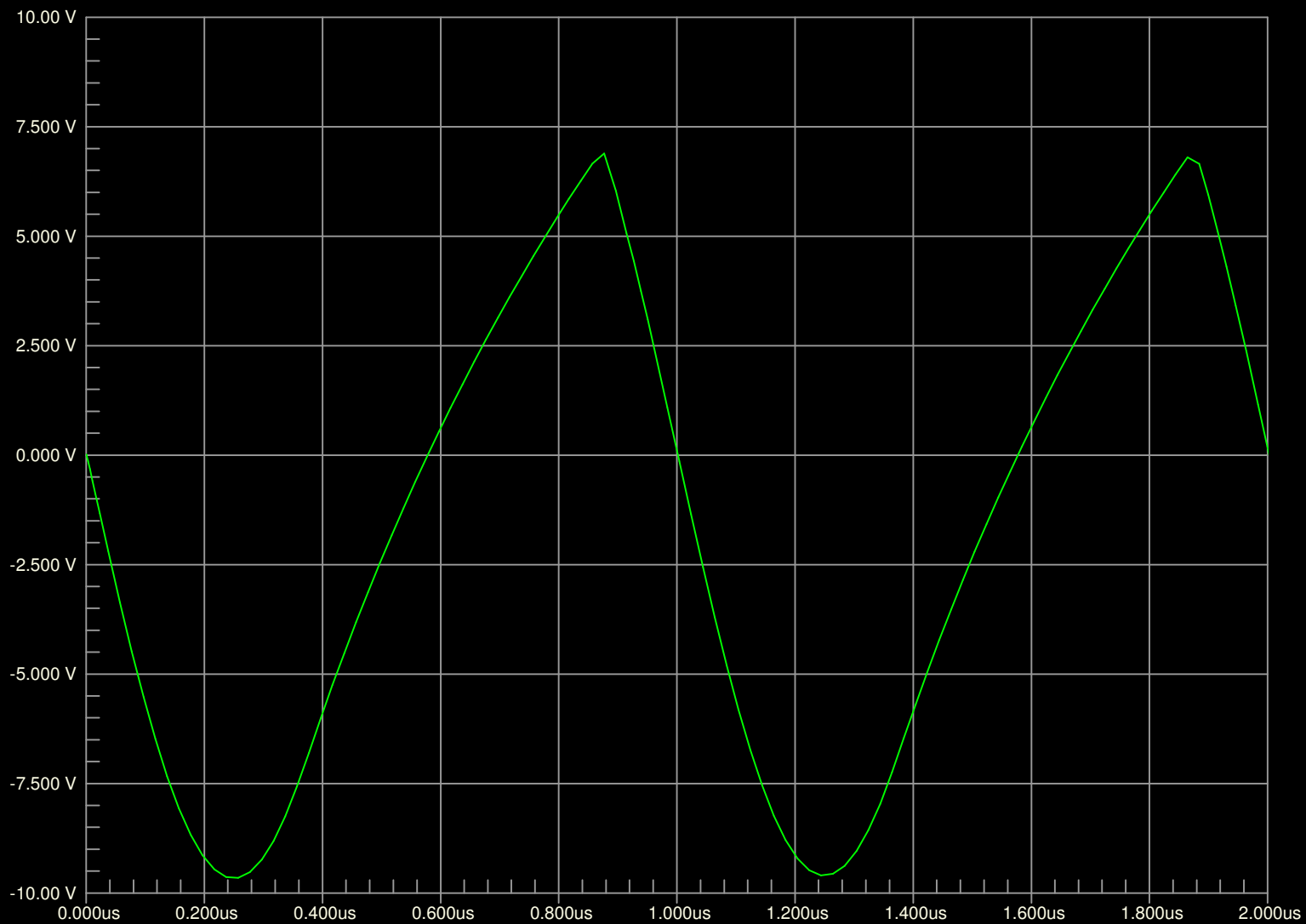

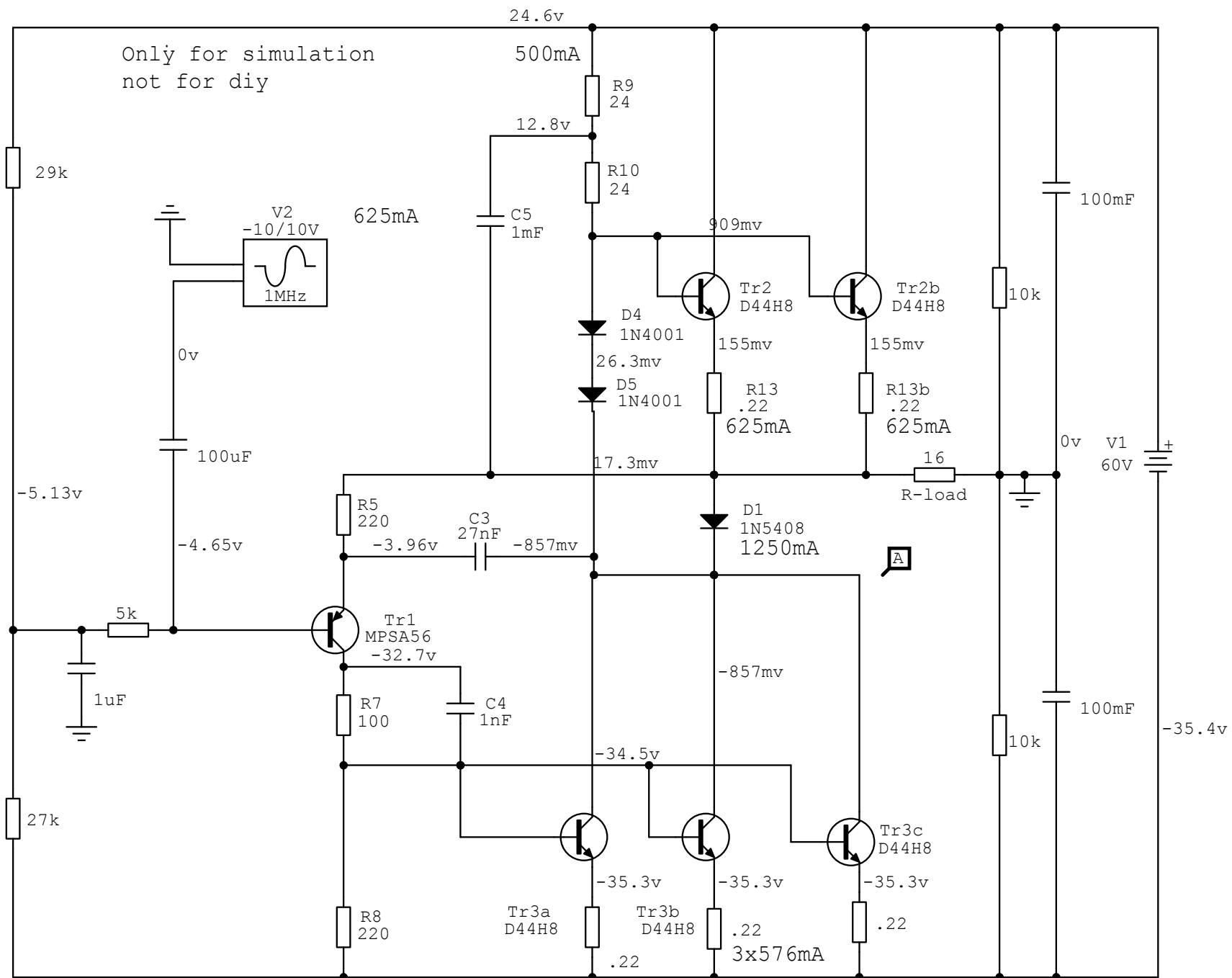

composite collector... (single ended buffer stage) based on Ollson III and <http://www.diyaudio.com/forums/showthread.php?s=&threadid=72149>

A: d1_a

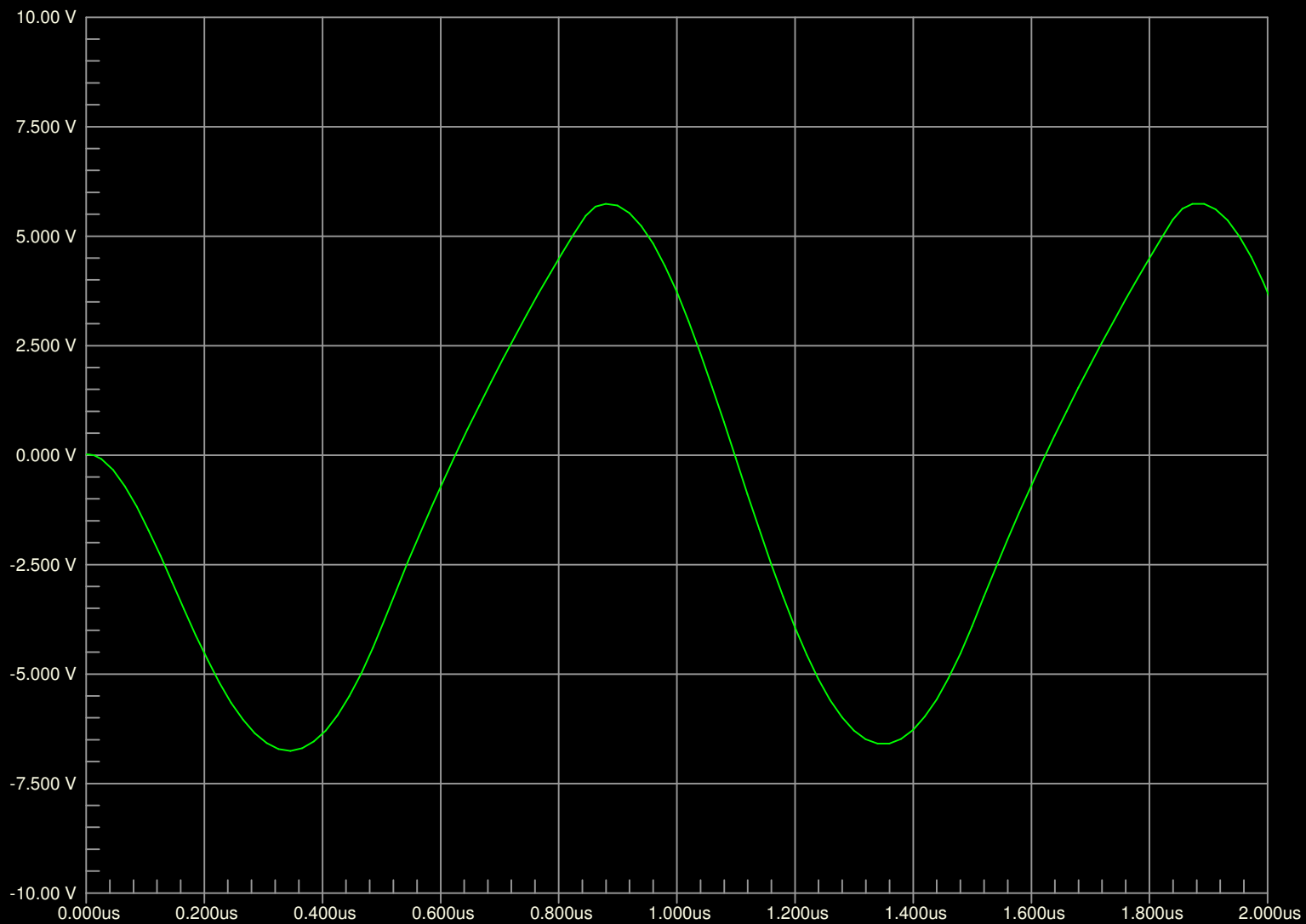

A: d1_a

