

A: r1\_1

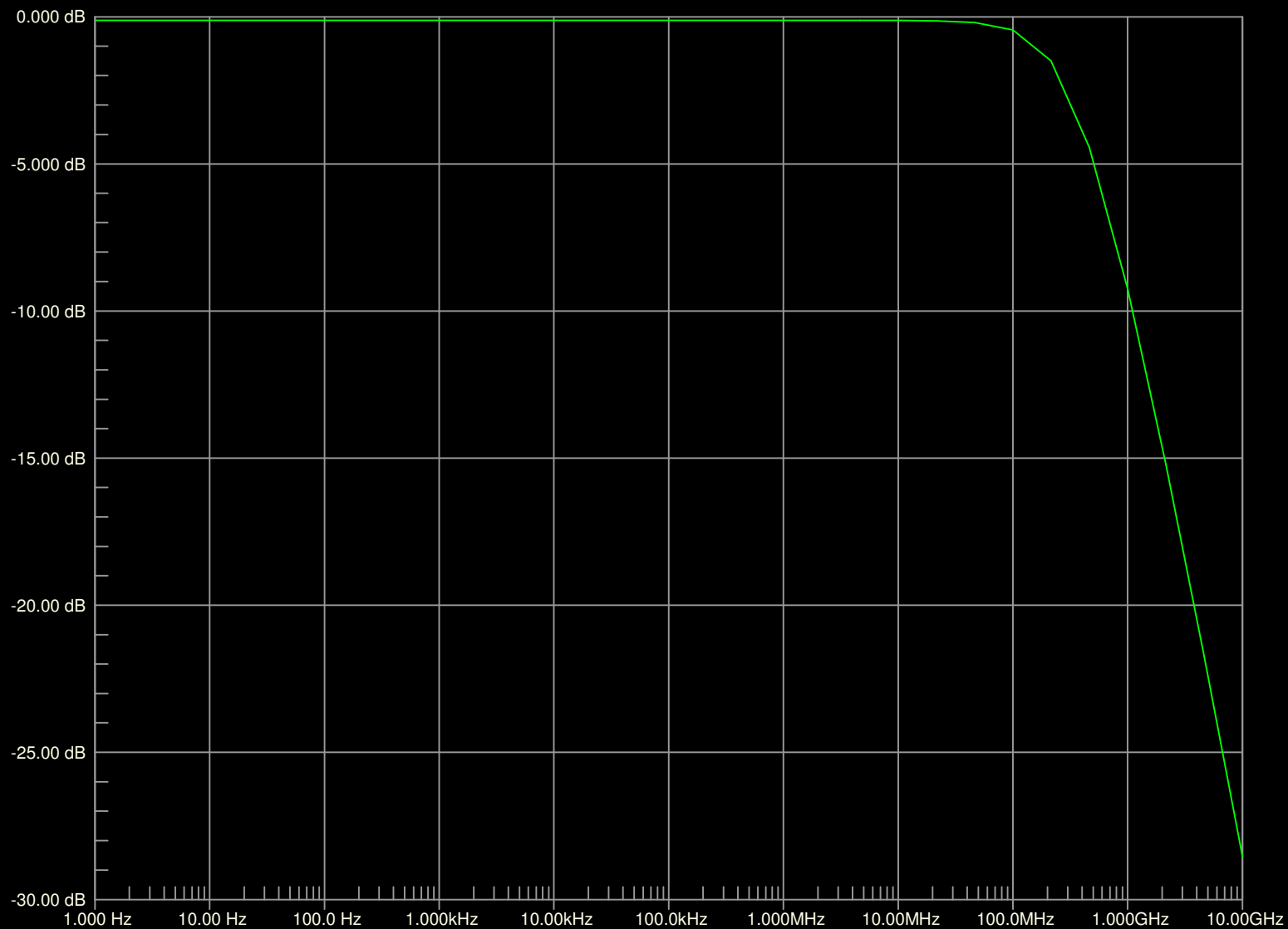

A: r1\_1

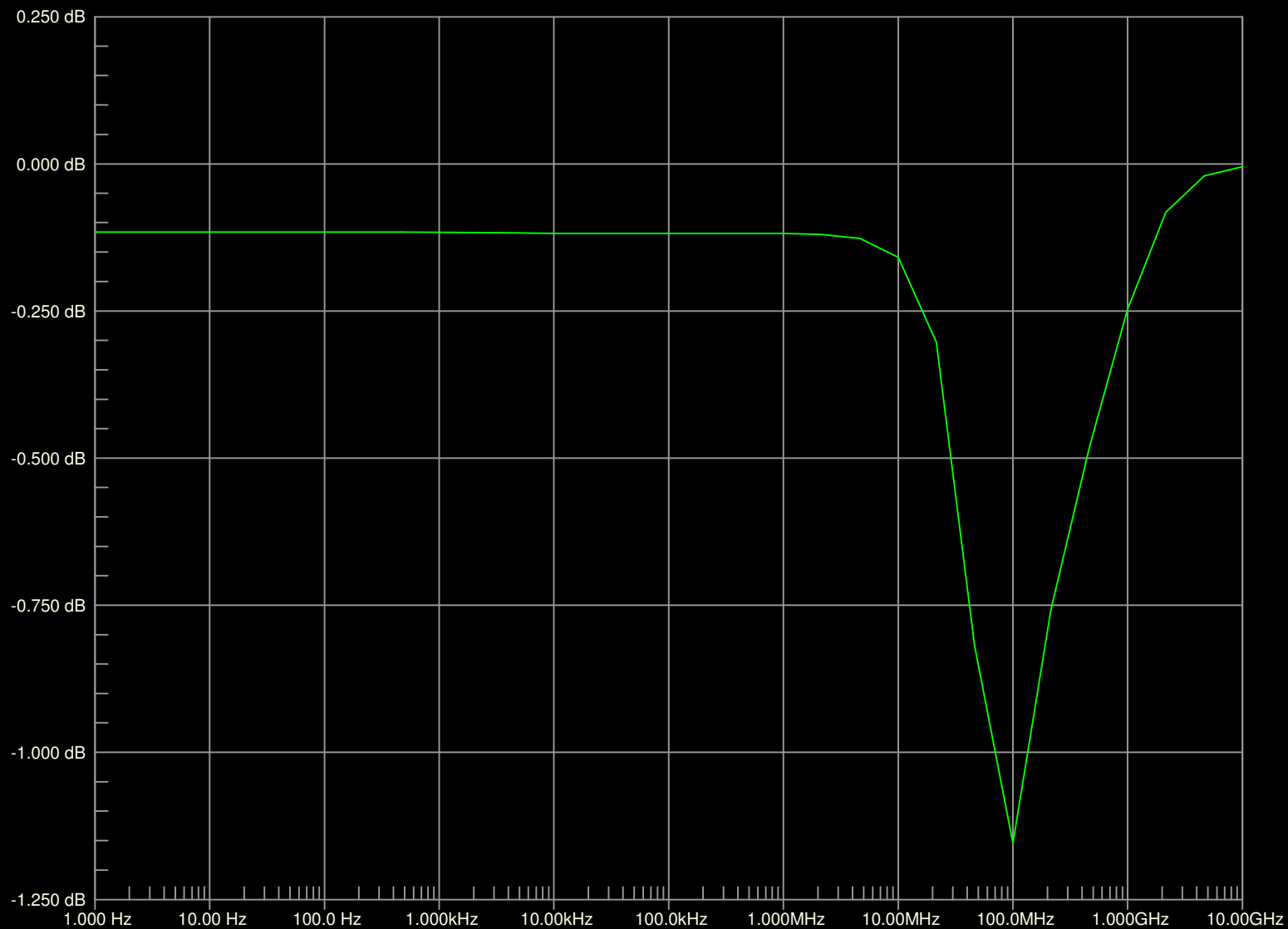

A: r1\_1

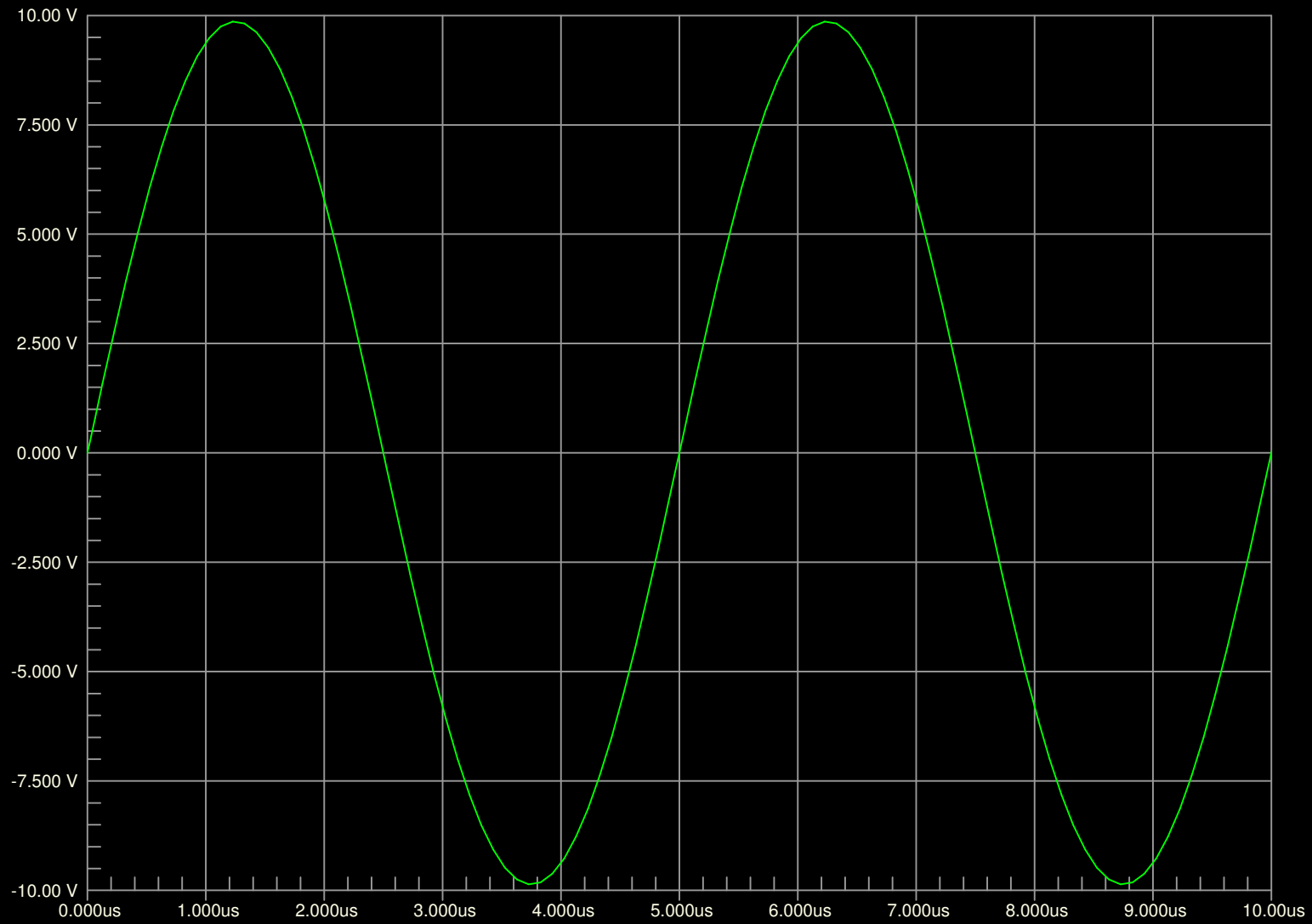

A: r1\_1

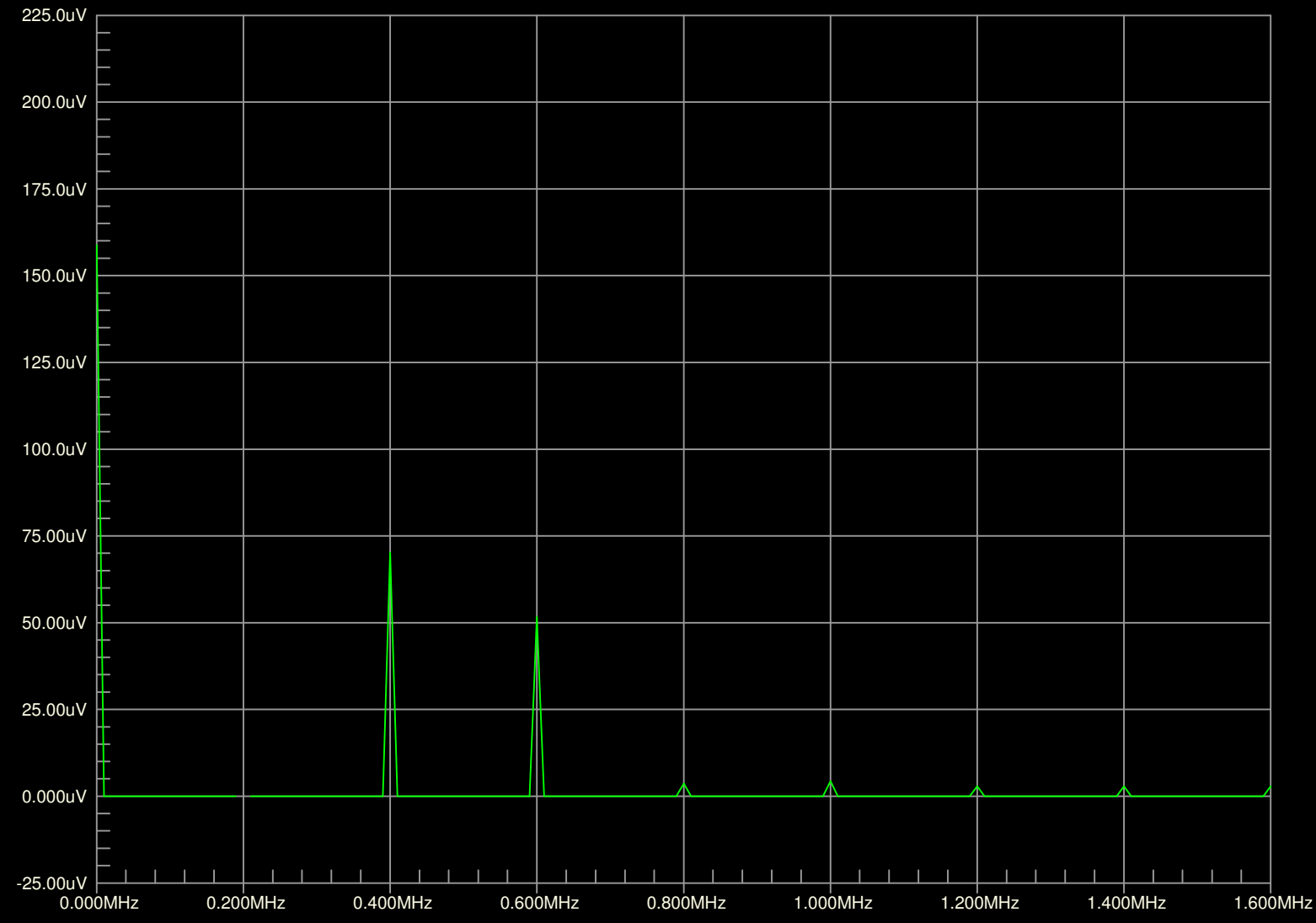

A: r1\_1

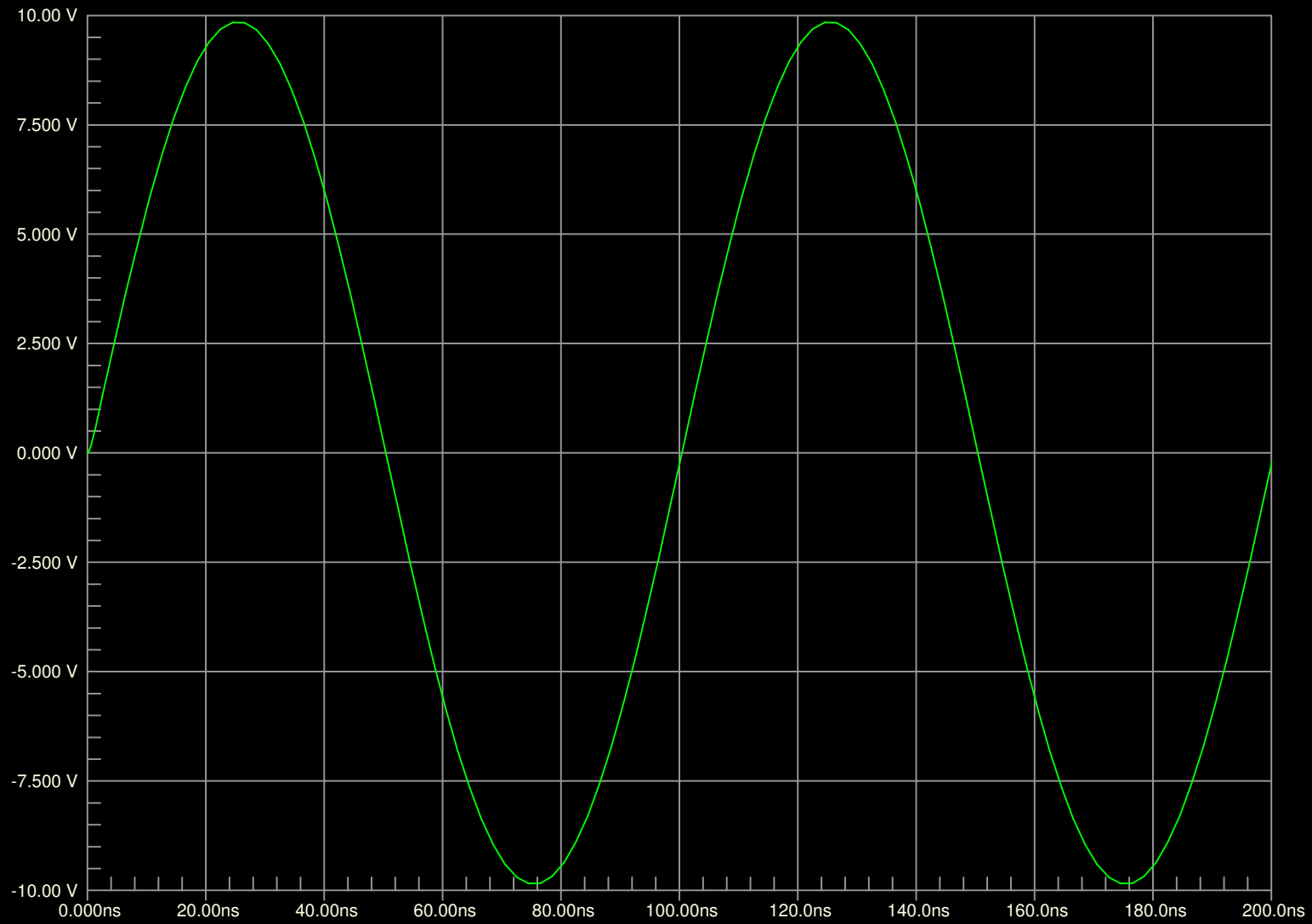

A: r1\_1

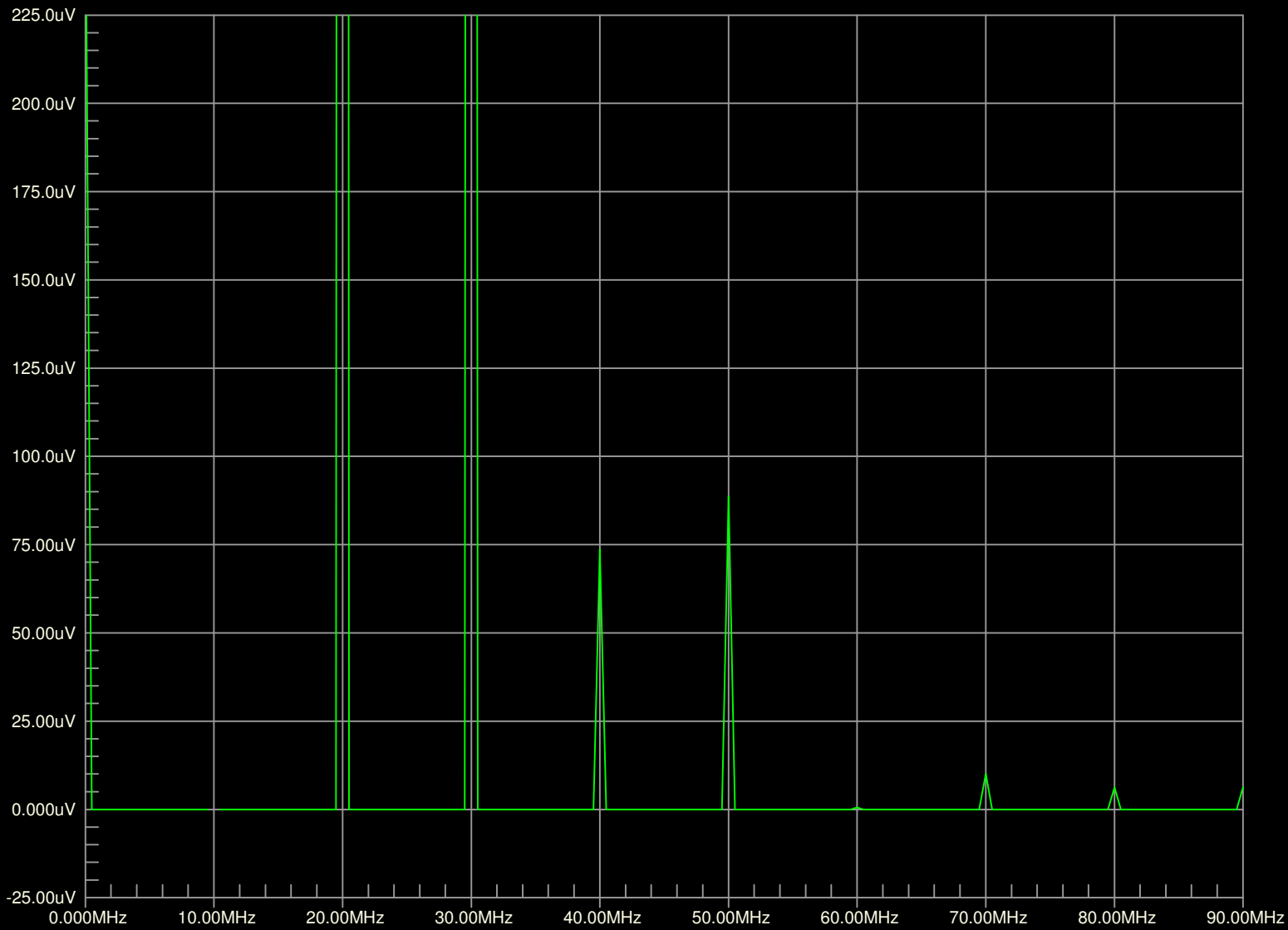

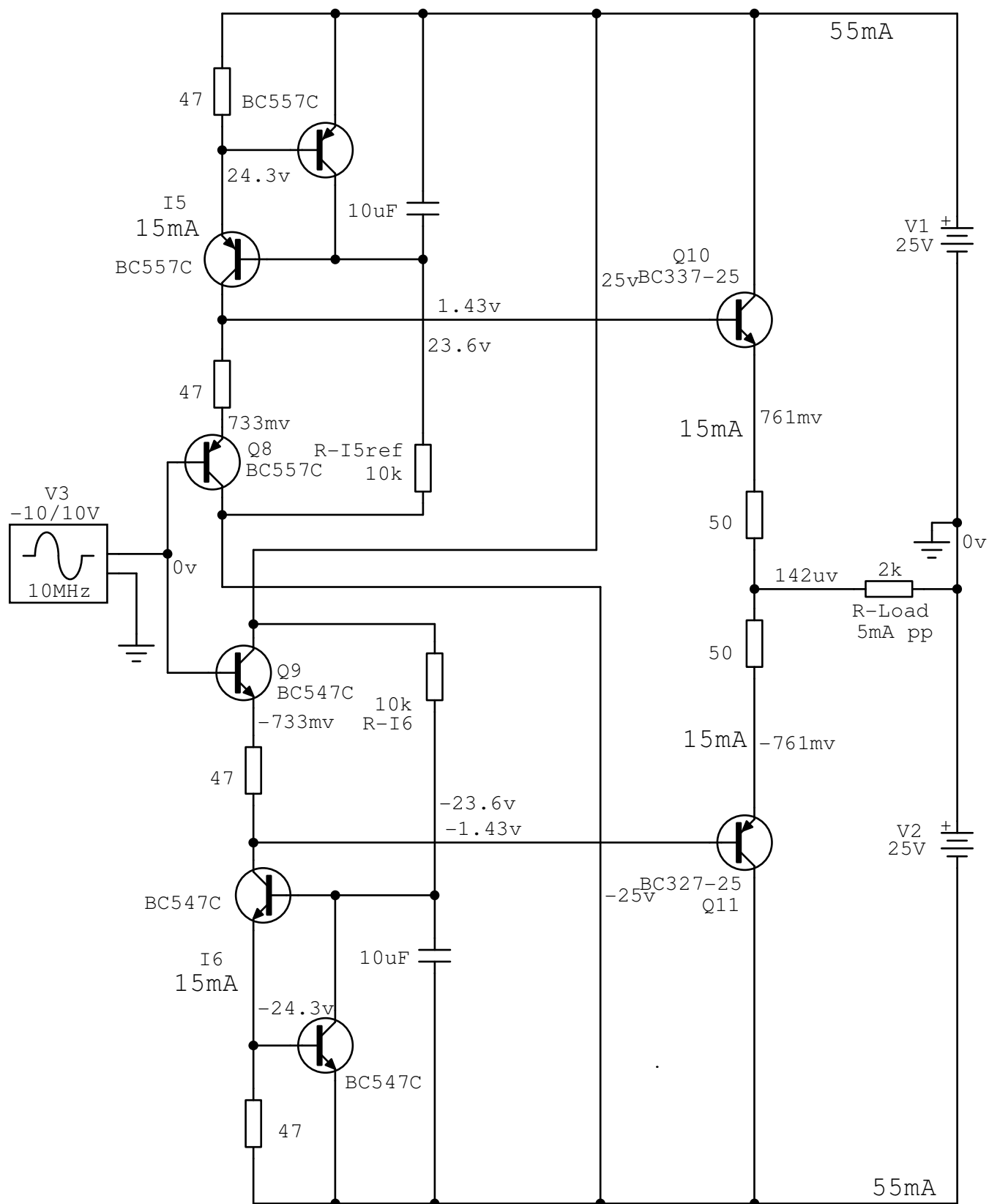

AD797 only BUF discrete, close by orig. circuit - please refer page 11 (rev G) from pdf datasheet about [http://www.analog.com/static/imported-files/data\\_sheets/AD797.pdf](http://www.analog.com/static/imported-files/data_sheets/AD797.pdf) or 9-85, "Design-in Reference Manual Analog Devices"