

A: c1_1

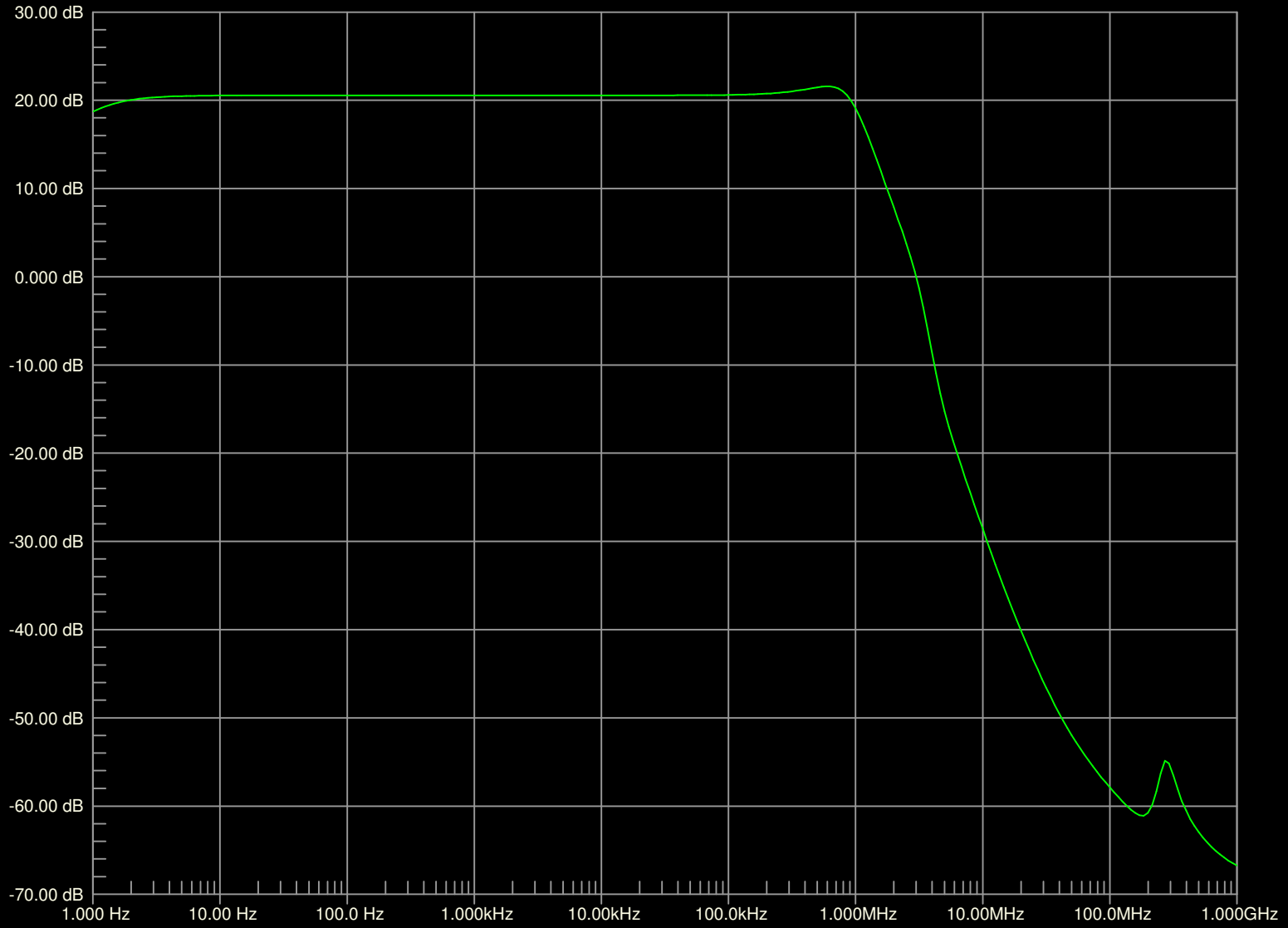

A: c1_1

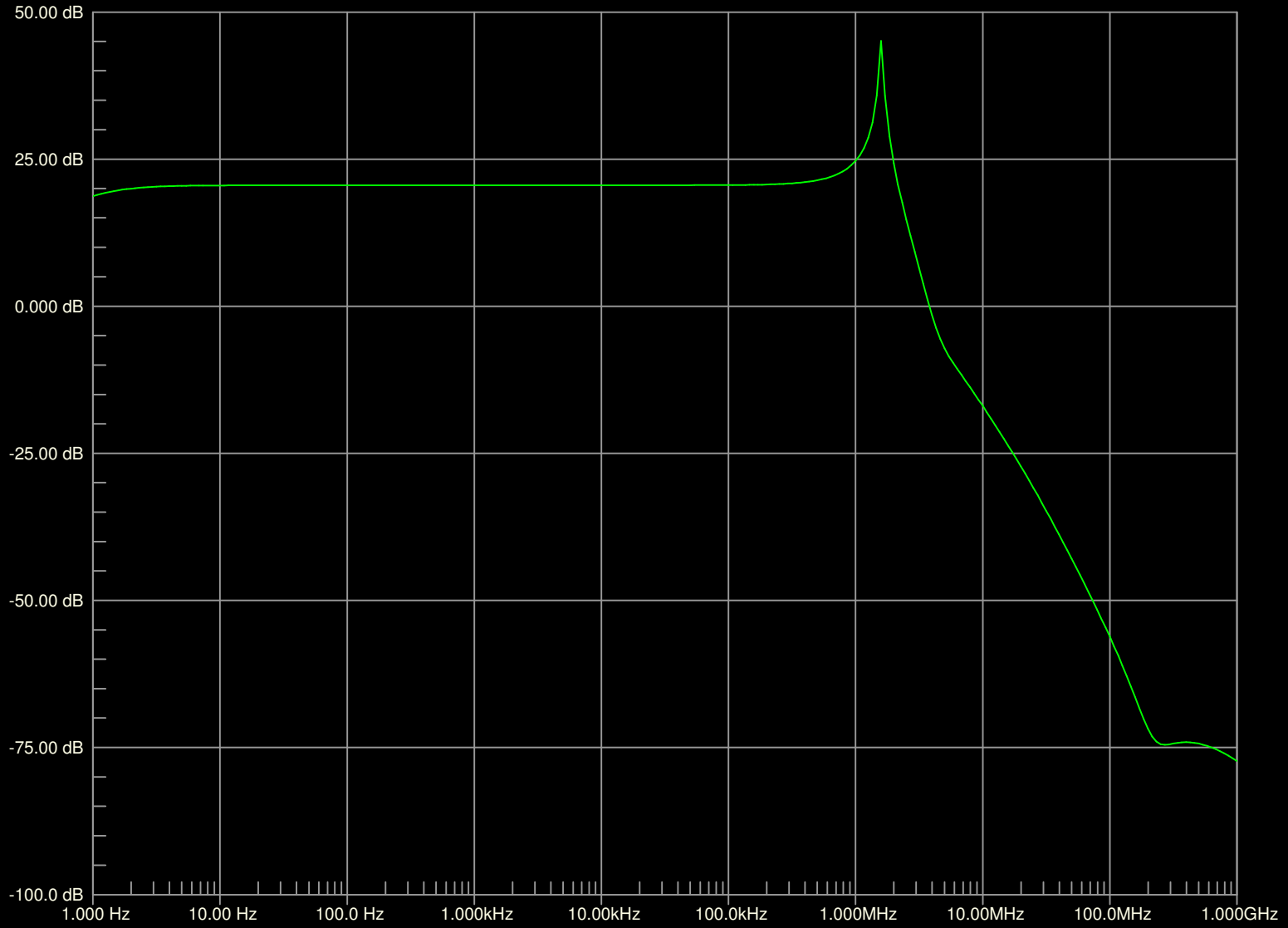

A: c1_1

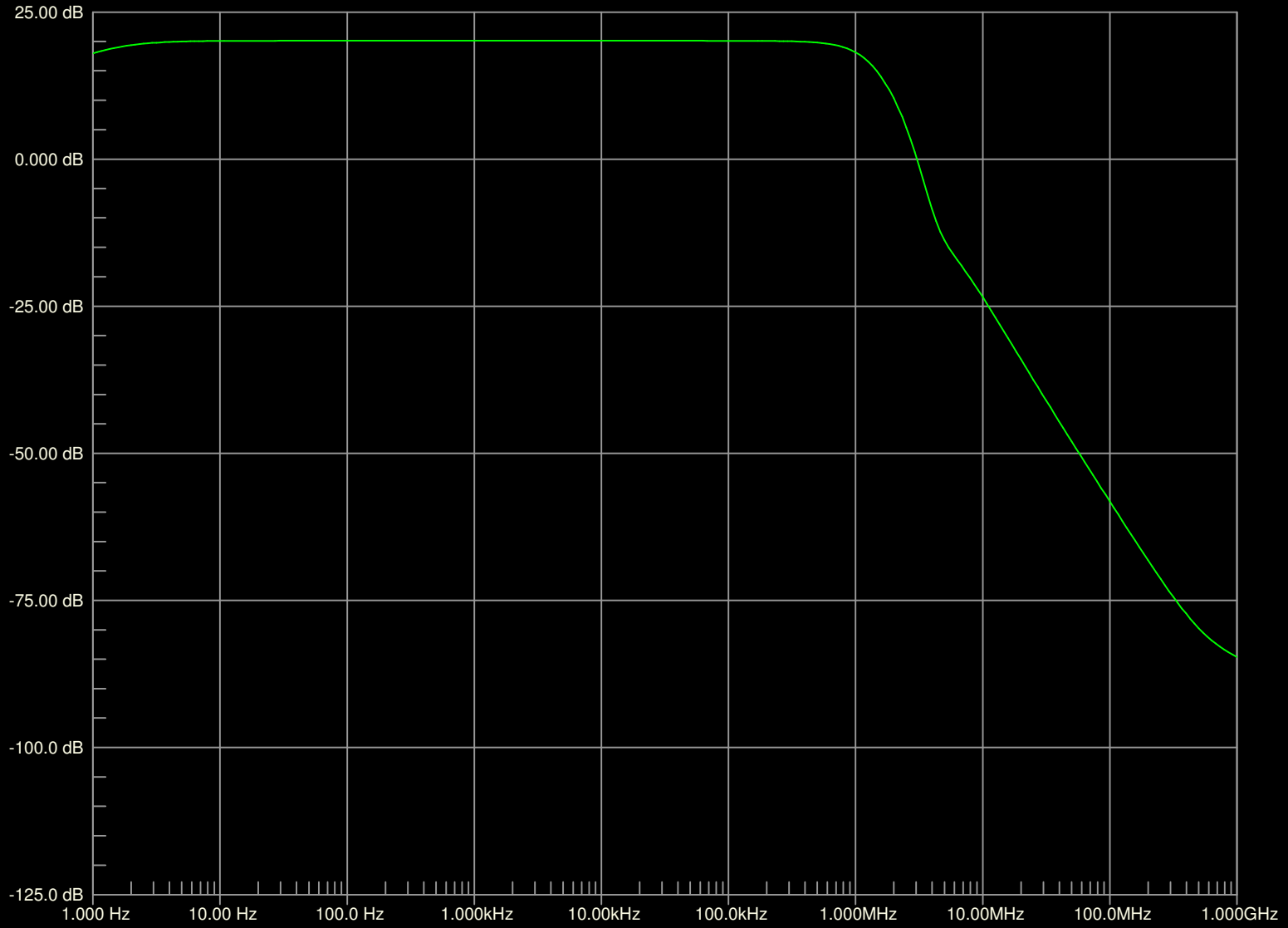

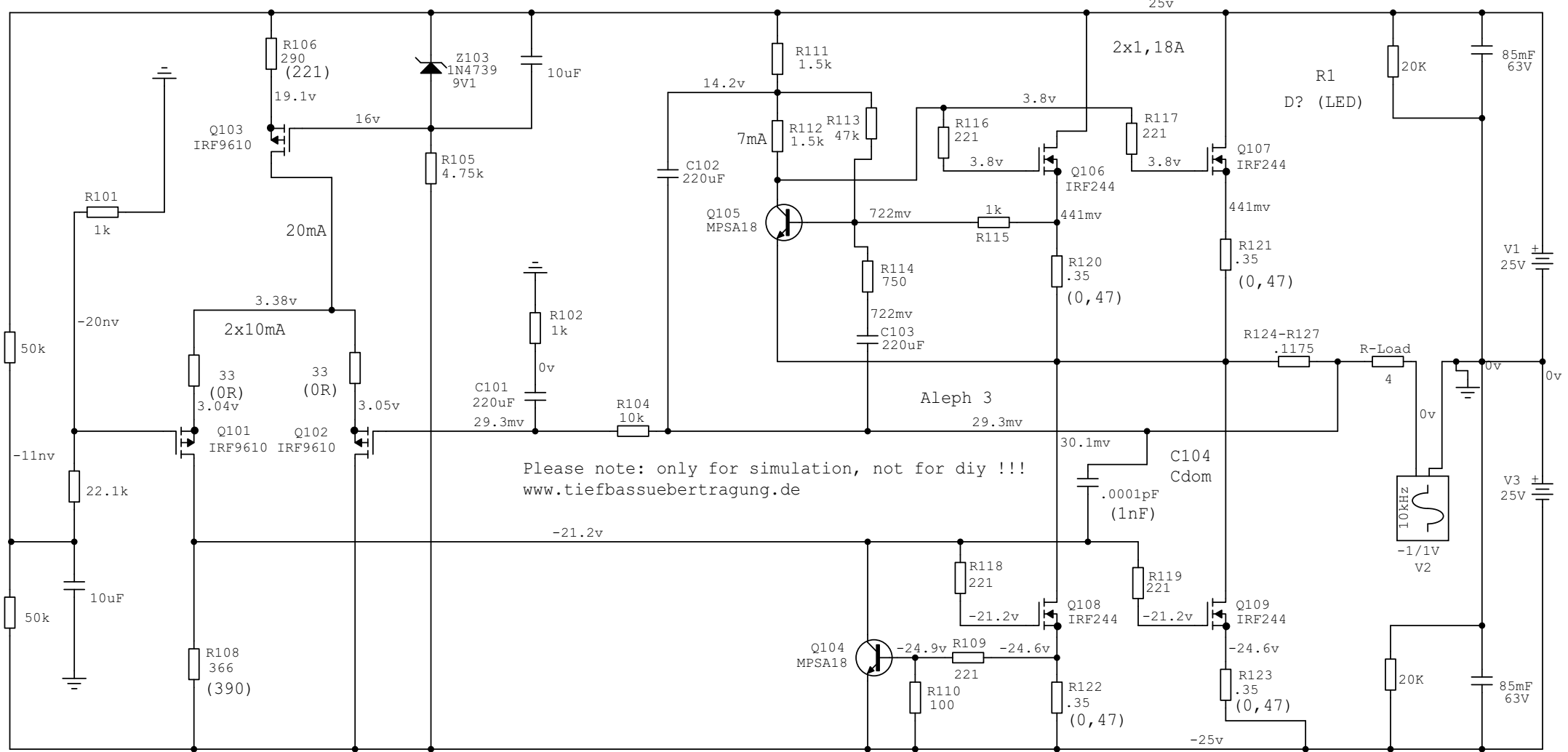

Please note: only for simulation, not for diy !!!
www.tiefbassuebertragung.de

www.passlabs.com
<http://www.stereophile.com/solidpoweramps/674/index9.html>
http://peufeu.free.fr/audio/schemas/Pass_Aleph_3.pdf

A: c1_1

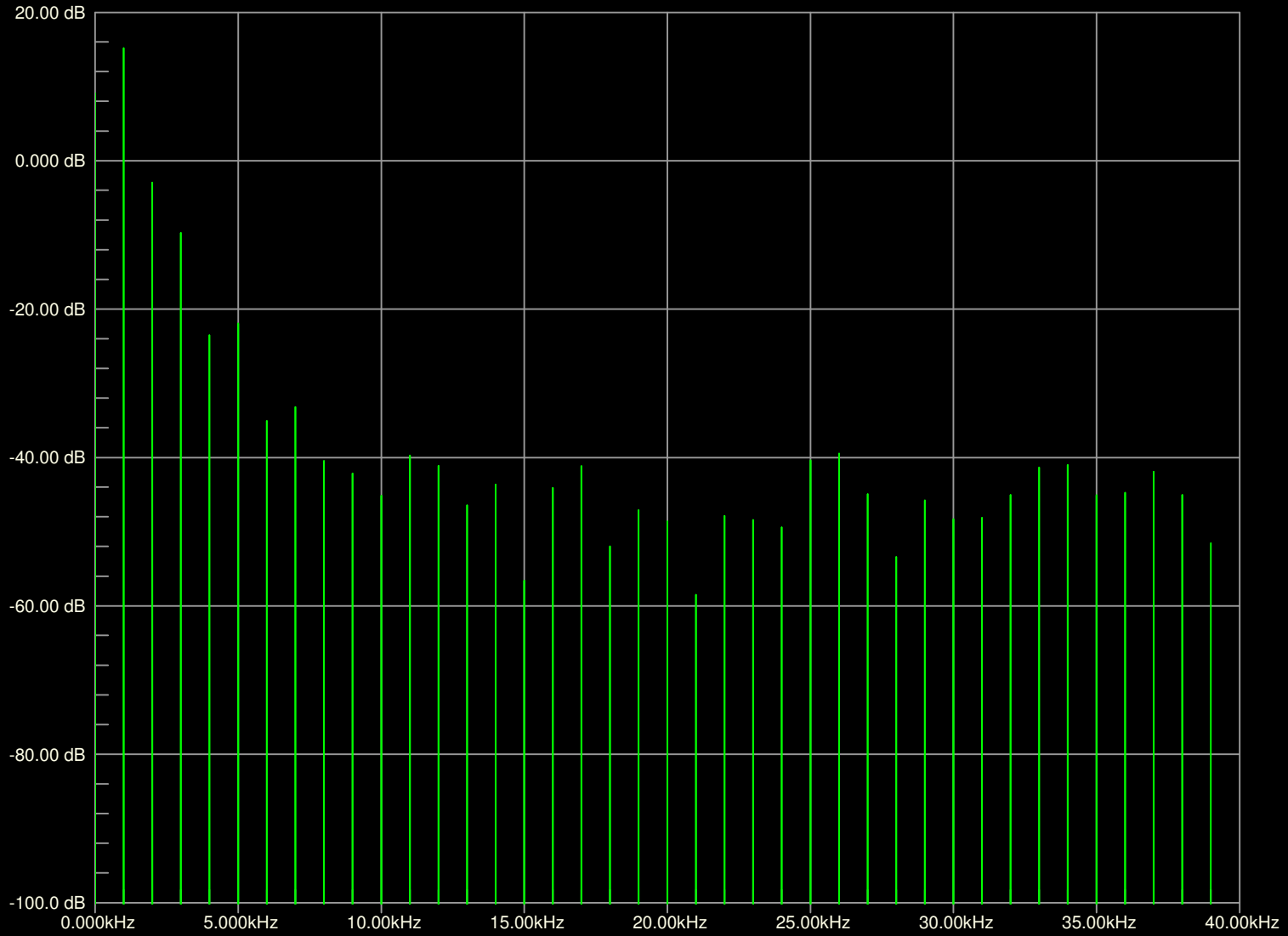

A: c1_1

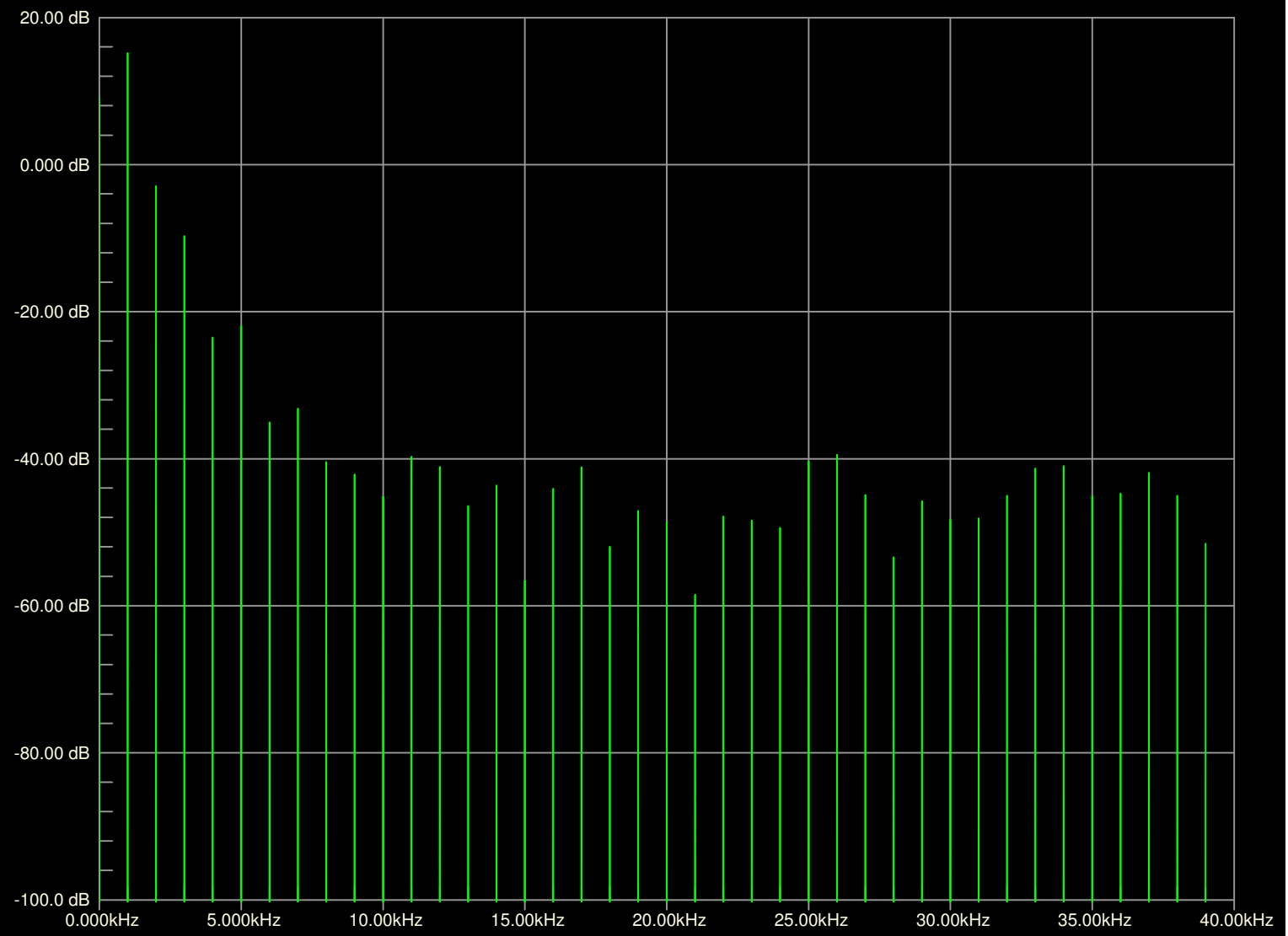

A: c1_1

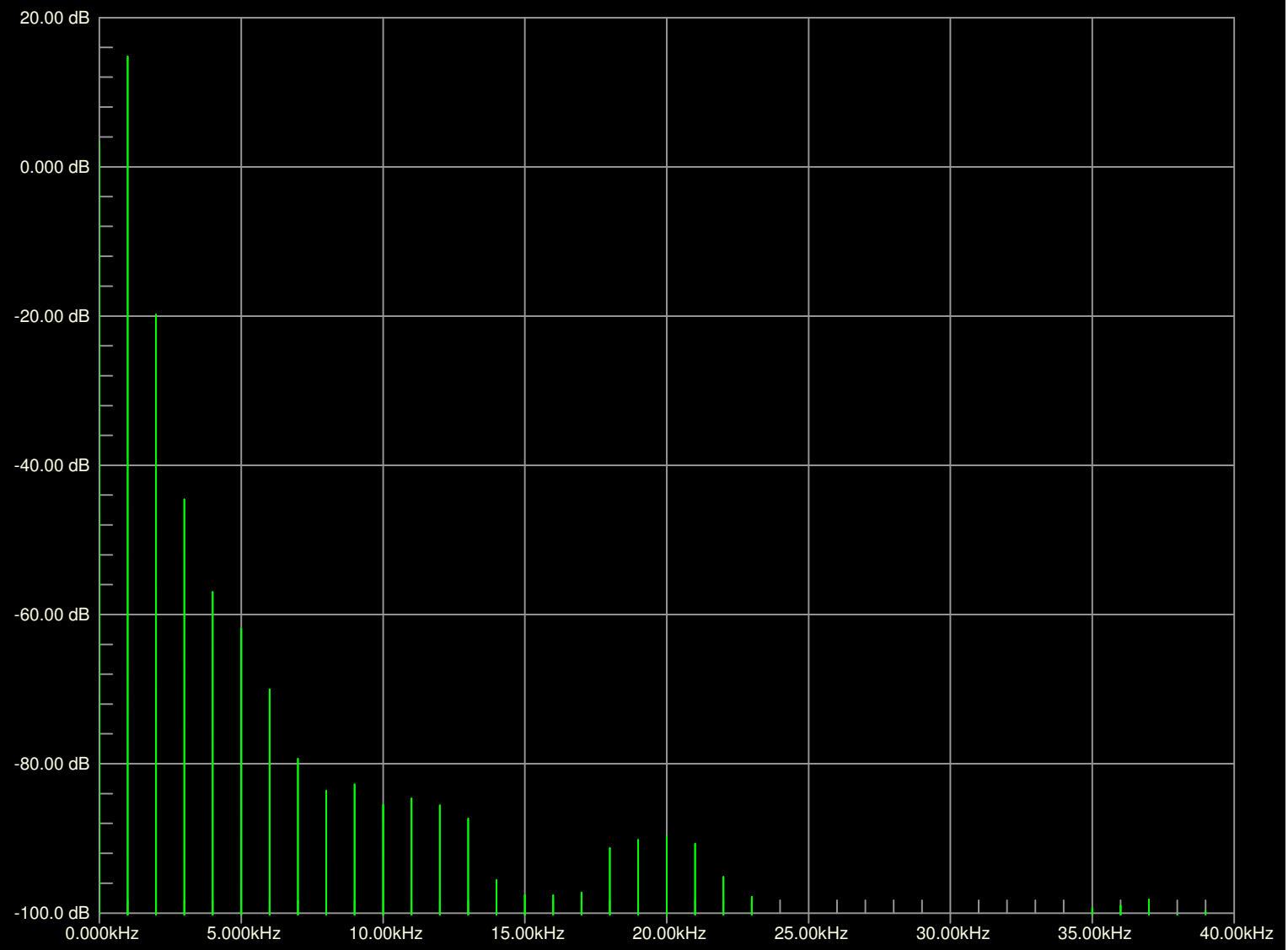

A: c1_1

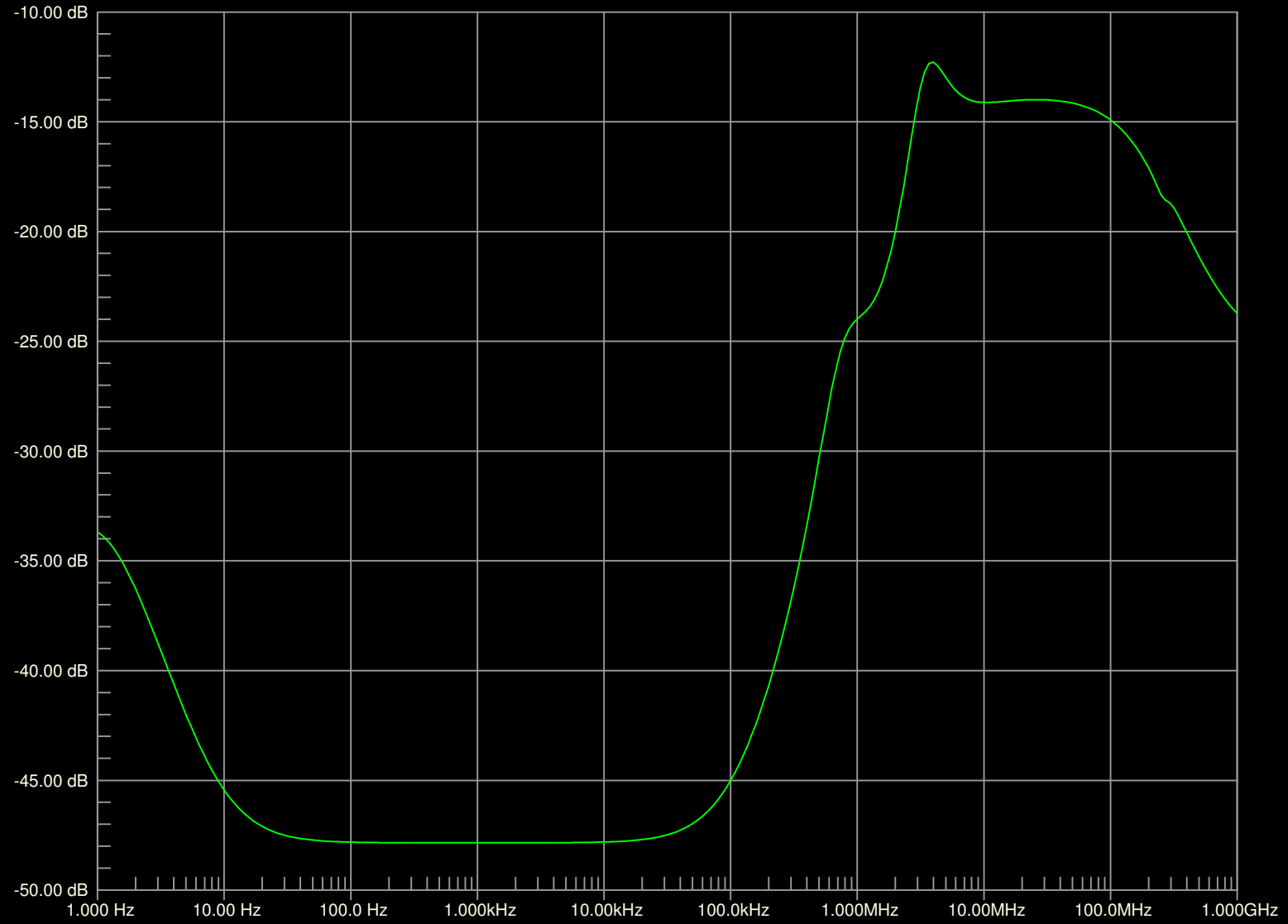

A: c1_1

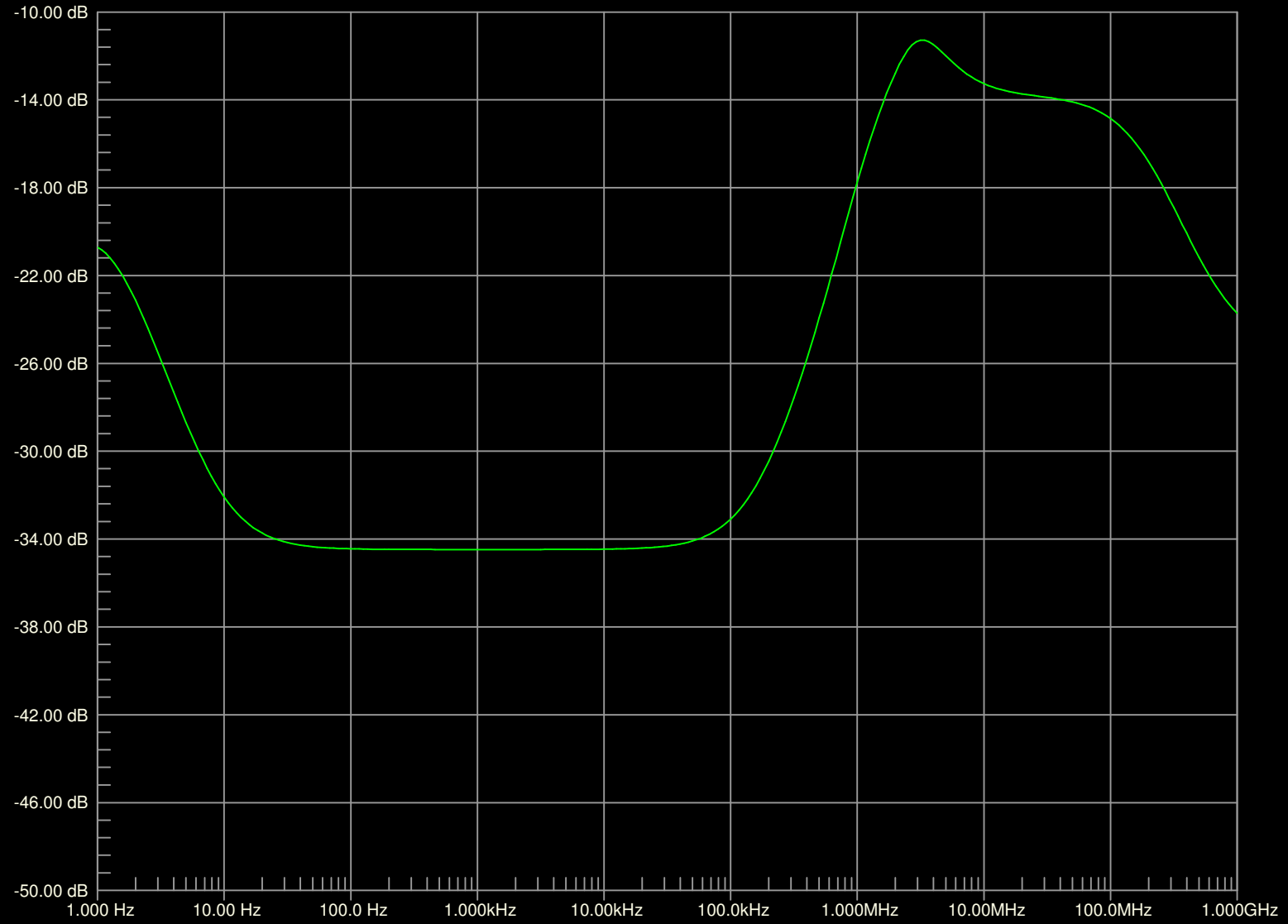

A: c2_2

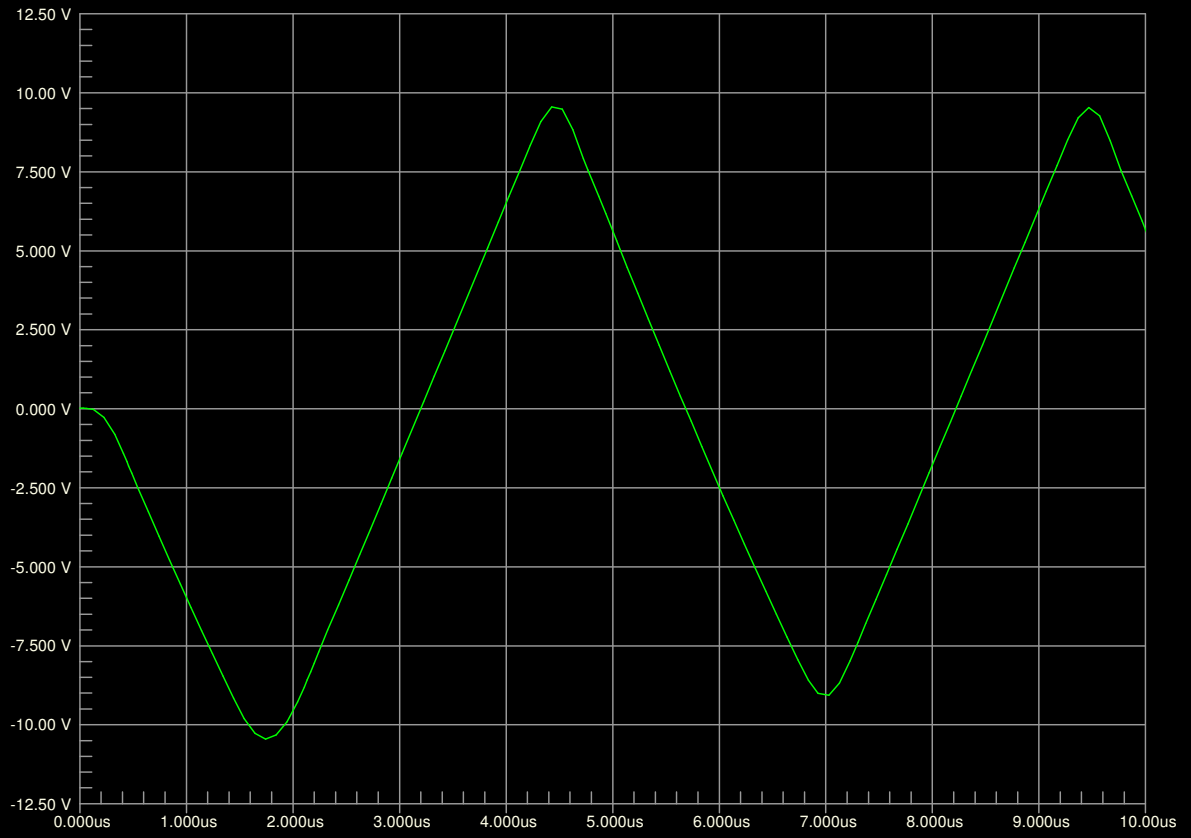

A: c2_2

