

ENERGIZER 522

9V

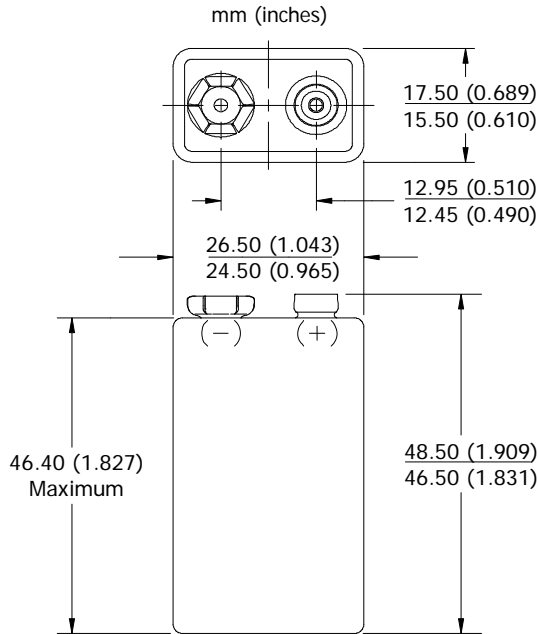

Industry Standard Dimensions



Specifications

<b>Classification:</b>	Alkaline
<b>Chemical System:</b>	Zinc-Manganese Dioxide (Zn/MnO <sub>2</sub> ) No added mercury or cadmium
<b>Designation:</b>	ANSI-1604A, IEC-6LR61
<b>Nominal Voltage:</b>	9.0 volts
<b>Operating Temp:</b>	-18°C to 55°C (0°F to 130°F)
<b>Typical Weight:</b>	45.6 grams (1.6 oz.)
<b>Typical Volume:</b>	21.1 cubic centimeters (1.3 cubic inch)
<b>Jacket:</b>	Metal
<b>Shelf Life:</b>	5 years at 21°C (80% of initial capacity)
<b>Terminal:</b>	Miniature Snap

Milliamp-Hours Capacity

Continuous discharge to 4.8 volts at 21°C

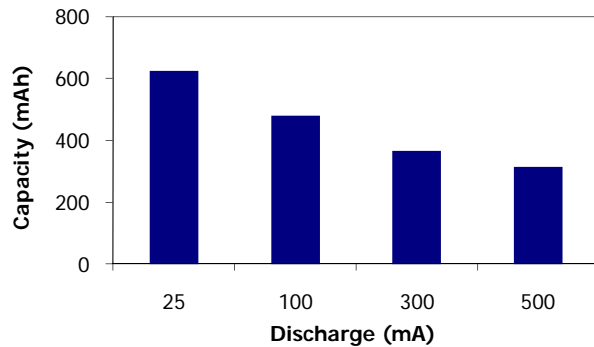

Device Selection Guide:

- Toy
- Baby Monitor
- Garage Opener
- Clock Radio
- Smoke Detector

Battery Selection Indicator

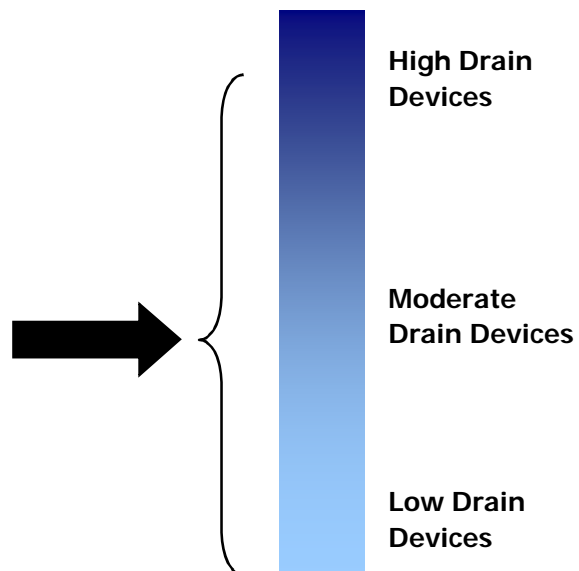

**Important Notice**

This datasheet contains typical information specific to products manufactured at the time of its publication.  
©Energizer Holdings, Inc. - Contents herein do not constitute a warranty.

# ENERGIZER 522

**9V**

## Constant Resistance Performance

Typical Characteristics (21°C)

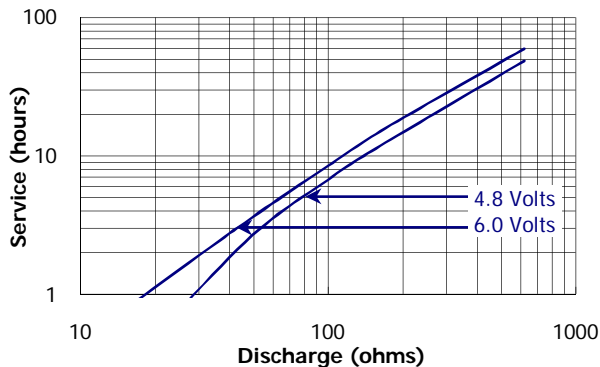

## Constant Current Performance

Typical Characteristics (21°C)

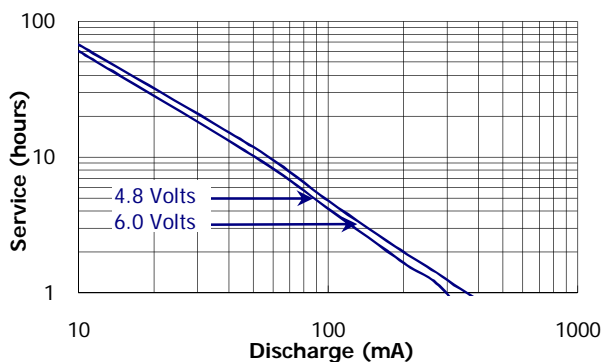

## Industry Standard Tests (21°C)

### RADIO

620 ohm 2 hrs/day

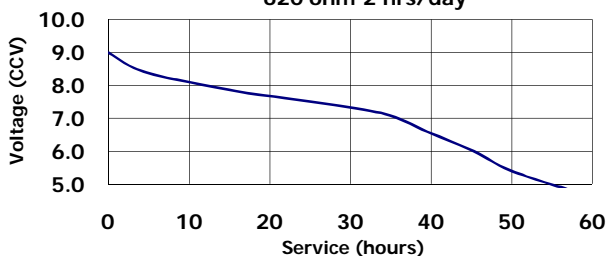

### TOY

270 ohm 1 hr/day

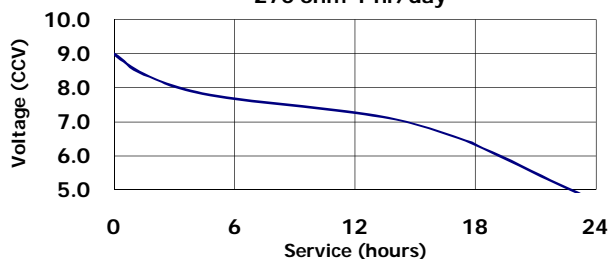

### ACCELERATED SMOKE DETECTOR

10K/620 ohm 1 sec/hr pulse

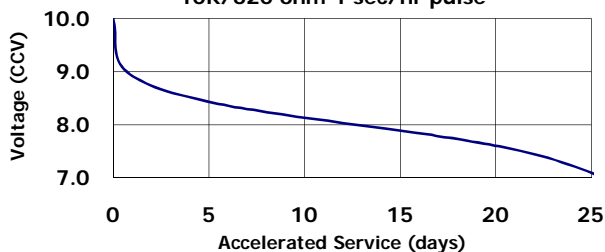

### Important Notice

This datasheet contains typical information specific to products manufactured at the time of its publication.  
©Energizer Holdings, Inc. - Contents herein do not constitute a warranty.