

▲ = COOLING REQUIRED

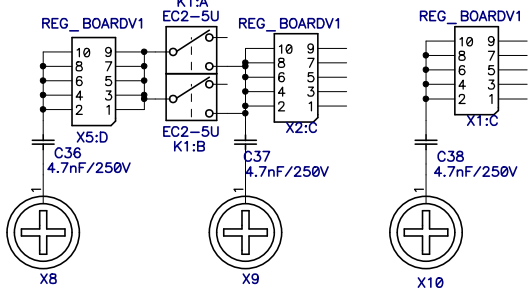

EPSUX3V2			Triple outputs Laboratory Power supply		Version 2.0
Po 160W max, Vin 90-250Vac			Outputs +/-20V-3A & +10V-4A		Page 1 / 4
Flyback SMPS			Wed Dec 09, 2015		
contact@oneaudio.net			Copyright OnE Audio Projects		
www.oneaudio.net			DIY use only, no commercial use		
Ver	Date	Nom			
2.00	12/09/15	O.N			

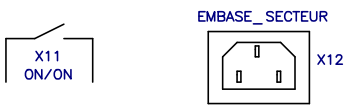

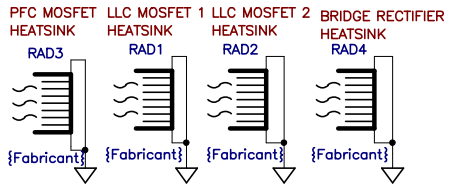
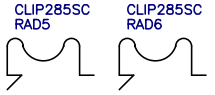
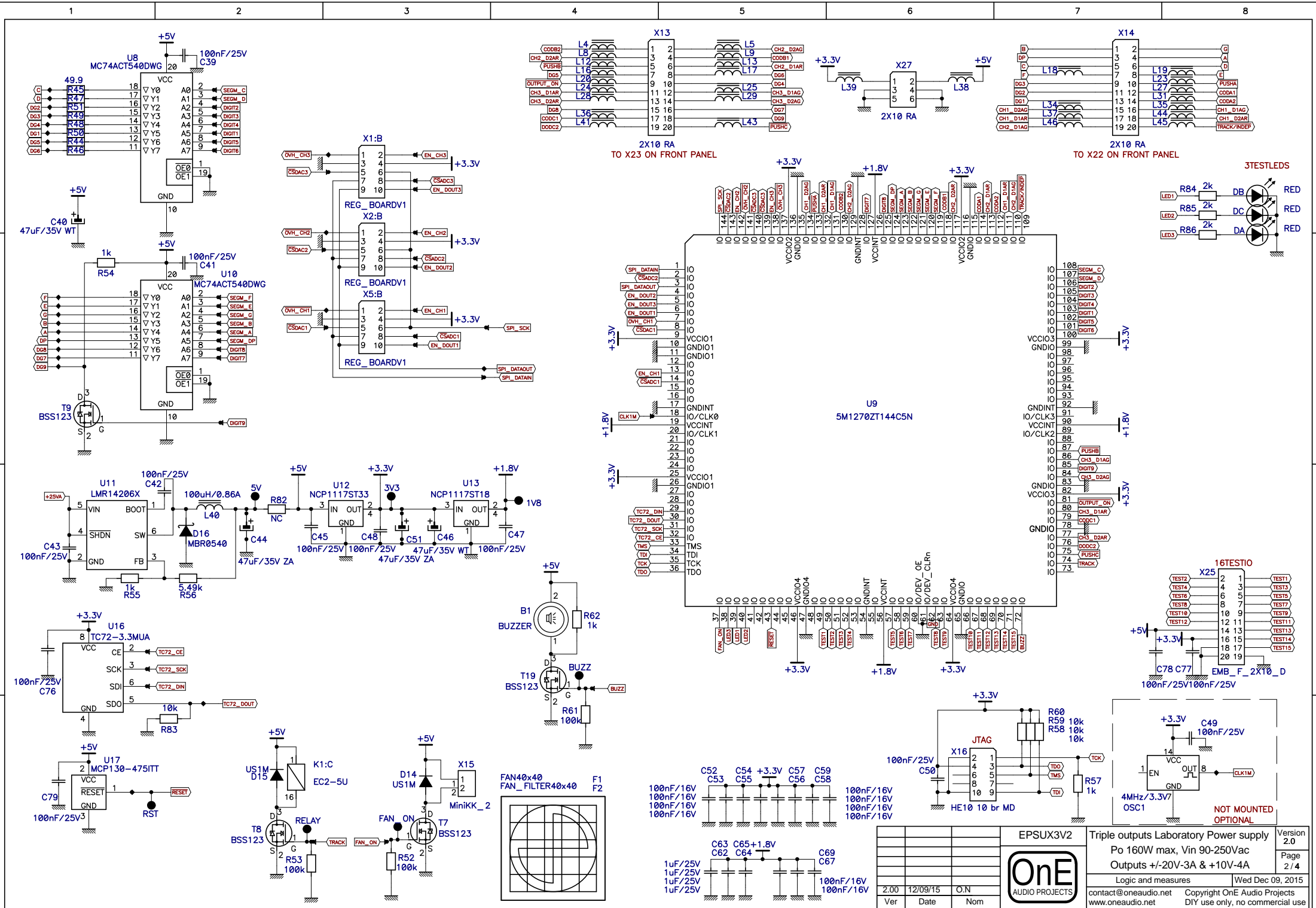

EPSUX3V2			Triple outputs Laboratory Power supply		Version 2.0
Po 160W max, Vin 90-250Vac			Outputs +/-20V-3A & +10V-4A		Page 2 / 4
Logic and measures			Wed Dec 09, 2015		
contact@oneaudio.net			Copyright OnE Audio Projects		
www.oneaudio.net			DIY use only, no commercial use		
Ver	Date	Nom			
2.00	12/09/15	O.N			

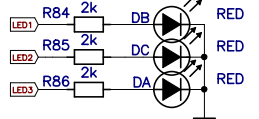
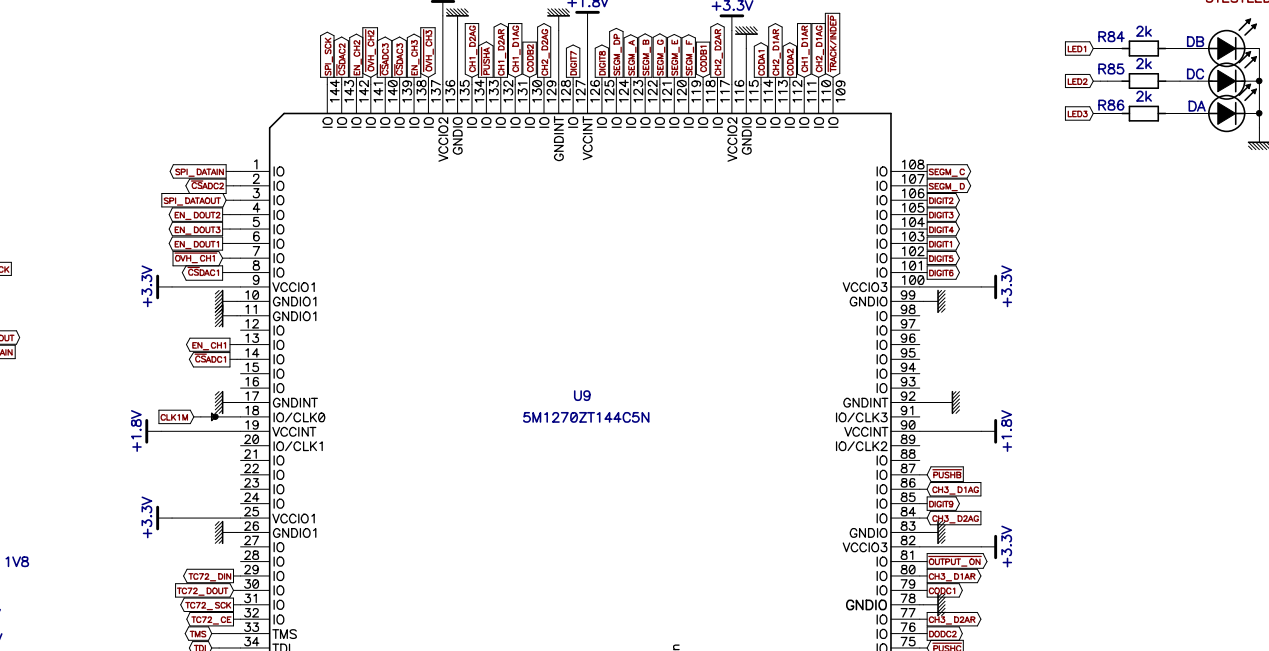
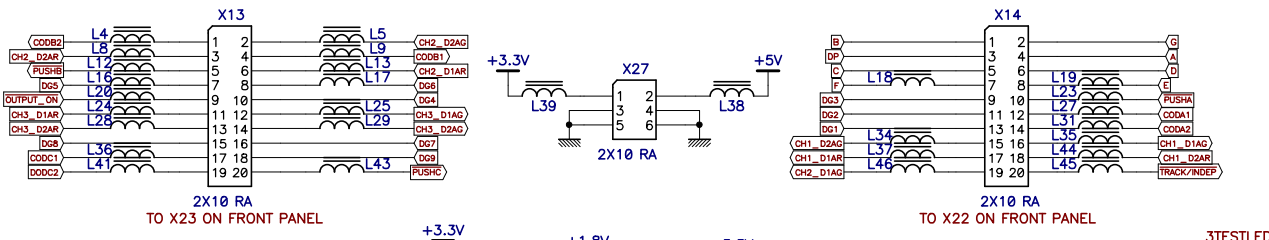
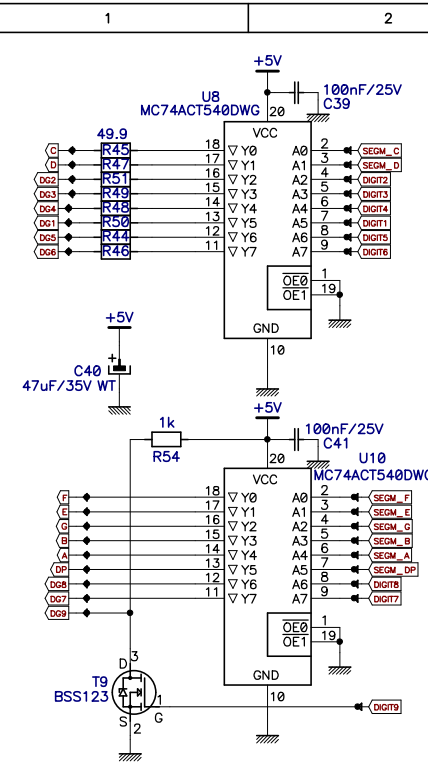
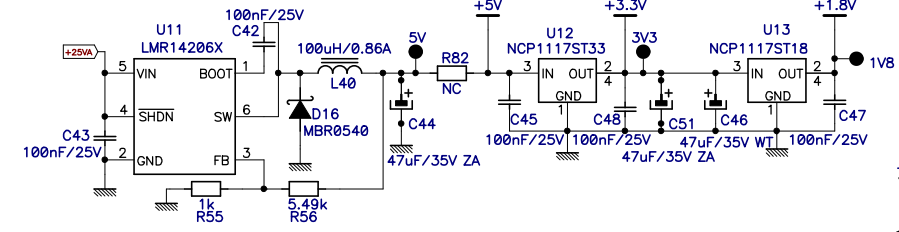
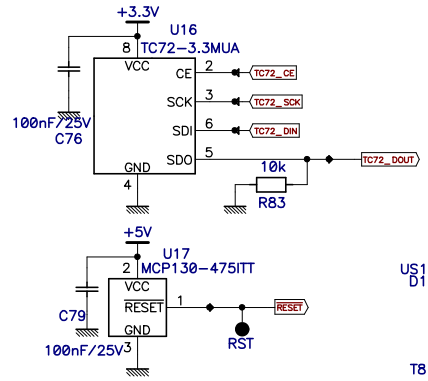
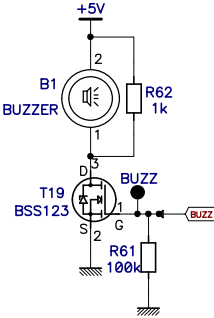
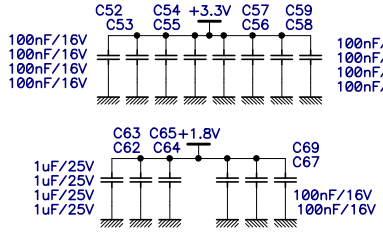
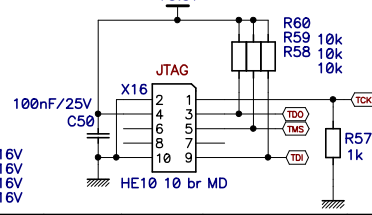
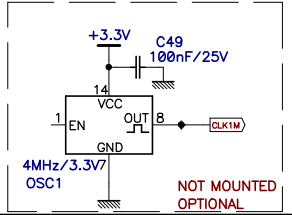
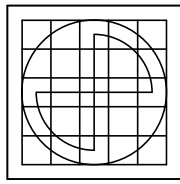

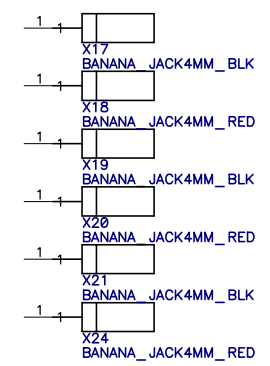
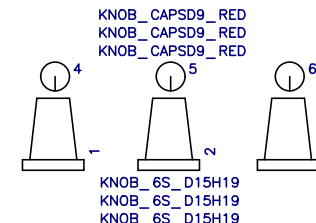
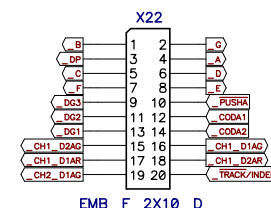
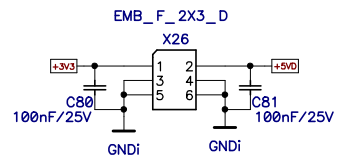
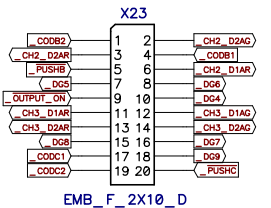
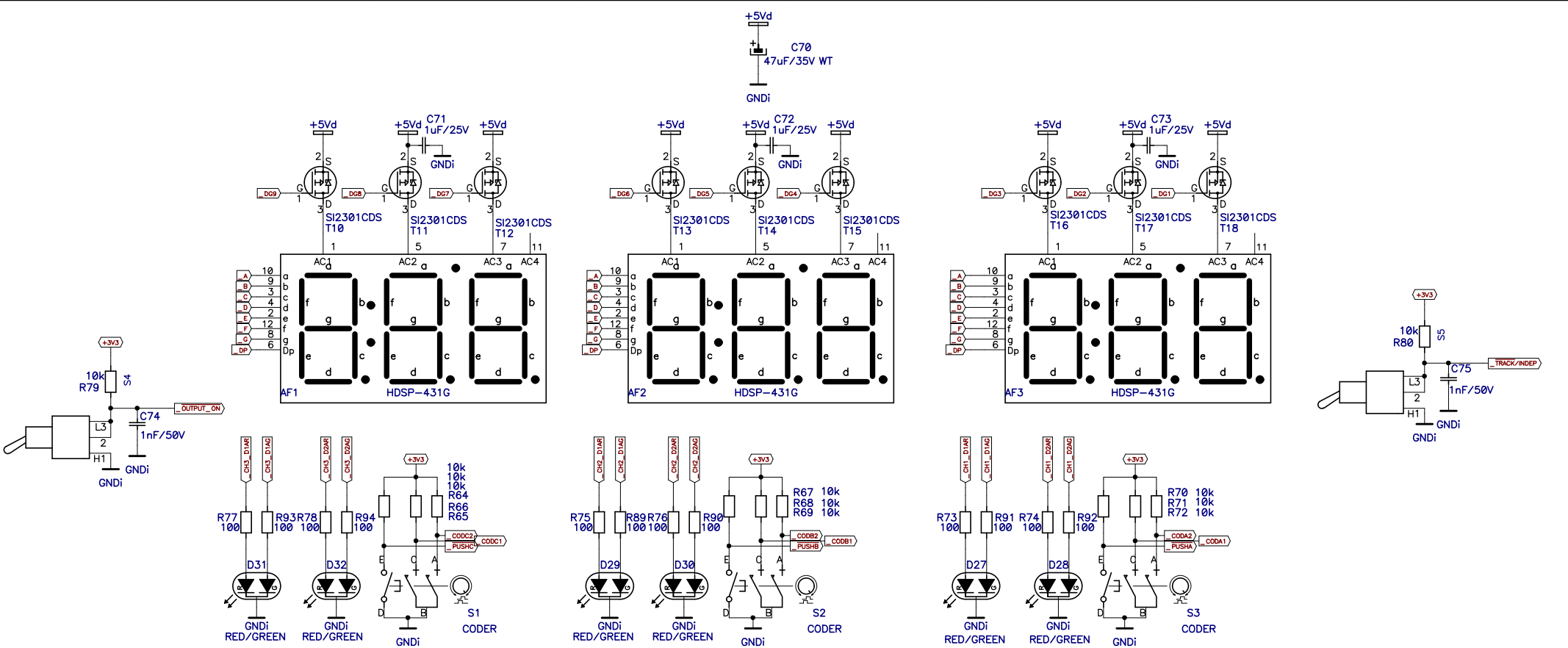

EPSUX3V2			Triple outputs Laboratory Power supply		Version 2.0
			Po 160W max, Vin 90-250Vac		Page 3 / 4
			Outputs +/-20V-3A & +10V-4A		
2.00			Front panel		Wed Dec 09, 2015
Date			Nom		
contact@oneaudio.net			Copyright OnE Audio Projects		
www.oneaudio.net			DIY use only, no commercial use		

Power Table									
Ref Des	Device(Type)	Package	GND	+5V	+3.3V	DGND	+1.8V	+VCC	+25VA
U1	NCP5304DR2G	SOIC8_N				4		3	
U2	NCP1654BD133R2G	SOIC8_N				1		7	
U3	STN1NK60Z	SOT223						3	
U4	UCC25600D	SOIC8_N				6		7	
U5	TL331DB	SOT23_5L				2		5	
U6	SFH6156-4T	DIP4_N_CMS				3			
U7	NCP431AVSN	SOT23_3L	3						
U8	MC74ACT540DWG	SOIC20_L	10,19,1	20					
U9	5M1270ZT144C5N	QFP144_0.5MM	61,99,92,83,78,115, 128,60,11,54,10,17, 26,135,65,47		100,82,116,136,64,46, 25,9		90,19,126,56		
U10	MC74ACT540DWG	SOIC20_L	10,19,1	20					
U11	LMR14206X	SOT23_6L	2						5,4
U12	NCP1117ST33	SOT223	1	3	4,2				
U13	NCP1117ST18	SOT223	1	3		4,2			
U16	TC72-3.3MUA	MSOP8	4		8				
U17	MCP130-475ITT	SOT23_3L	3	2					

Logic and measures[1A]	RESET
Logic and measures[3D]	OVH_CH3
Logic and measures[3D]	OVH_CH2
Logic and measures[3C]	OVH_CH1
Logic and measures[3D]	CSDAC3
Logic and measures[3C]	CSDAC2
Logic and measures[3C]	CSDAC1
Logic and measures[3D]	CSADC3
Logic and measures[3C]	CSADC2
Logic and measures[3C]	CSADC1
Logic and measures[2A]	TRACK
Logic and measures[1B]	TC72_SCK
Logic and measures[2A]	TC72_DOUT
Logic and measures[1B]	TC72_DIN
Logic and measures[1B]	TC72_CE
Logic and measures[3C]	SPI_SCK
Logic and measures[3C]	SPI_DATAOUT
Logic and measures[3C]	SPI_DATAIN
Logic and measures[2C]	SEGM_G
Logic and measures[2C]	SEGM_F
Logic and measures[2C]	SEGM_E
Logic and measures[2C]	SEGM_DP
Logic and measures[2D]	SEGM_D
Logic and measures[2D]	SEGM_C
Logic and measures[2C]	SEGM_B
Logic and measures[2C]	SEGM_A
Logic and measures[1C]	G
Logic and measures[3A]	FAN_ON
Logic and measures[1C]	F
Logic and measures[3D]	EN_DOUT3
Logic and measures[3C]	EN_DOUT2
Logic and measures[3C]	EN_DOUT1
Logic and measures[3D]	EN_CH3
Logic and measures[3D]	EN_CH2
Logic and measures[3C]	EN_CH1
Logic and measures[1C]	E
Logic and measures[1C]	DP
Logic and measures[2C]	DIGIT9
Logic and measures[2C]	DIGIT8
Logic and measures[2C]	DIGIT7
Logic and measures[2D]	DIGIT6
Logic and measures[2D]	DIGIT5
Logic and measures[2D]	DIGIT4
Logic and measures[2D]	DIGIT3
Logic and measures[2D]	DIGIT2
Logic and measures[2D]	DIGIT1
Logic and measures[1C]	DG9
Logic and measures[1C]	DG8
Logic and measures[1C]	DG7
Logic and measures[1D]	DG6
Logic and measures[1D]	DG5
Logic and measures[1D]	DG4
Logic and measures[1D]	DG3
Logic and measures[1D]	DG2
Logic and measures[1D]	DG1
Logic and measures[1D]	D
Logic and measures[8A][4C]	CLK1M
Logic and measures[1D]	C
Logic and measures[4B]	BUZZ
Logic and measures[1C]	B
Logic and measures[1C]	A
Sheets	Net Name

Spare Gate Table		
Last Used	Not Used	Spare Gates
1V8	1V1, 1V2, 1V3, 1V4, 1V5, 1V6, 1V7	
2V5	2V1, 2V3, 2V4	
3V3	3V1, 3V2	
5V		
25V		
AF3		
B1		
BIAS		
BIAS_START		
BR1		
BUZZ		
C81	C60, C61, C66, C68	
D32	D19, D20, D21, D22, D23, D24, D25, D26	
DA		
DB		
DC		
DRV		
EARTH		
F2		
FAN_ON		
FBK		
GA		
GB		
K1		
KLED		
L46	L6, L7, L10, L11, L14, L15, L21, L22, L26, L30, L32, L33, L42	
N		
OC		
OSC1		
PH		
PT6	PT2, PT3, PT4	
R94	R37, R63, R87, R88	
RAD6		
RELAY		
RST		
S5		
SUP_F1		
T19		
TR5		
U17	U14, U15	
VR2		
X27	X3, X4, X6	
LLC		

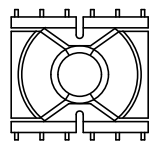

PQ2620\_CORE\_N87  
PQ2620\_COILFORMER  
TR2  
TR3

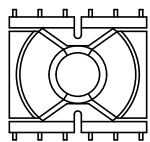

PQ3230\_CORE\_N87  
PQ3230\_COILFORMER  
TR5  
TR4

EPSUX3V2			Triple outputs Laboratory Power supply		Version 2.0
			Po 160W max, Vin 90-250Vac		Page 4 / 4
			Outputs +/-20V-3A & +10V-4A		
			Tables 2		Wed Dec 09, 2015
2.00	12/09/15	O.N			
Ver	Date	Nom			
					contact@oneaudio.net www.oneaudio.net
			Copyright OnE Audio Projects		DIY use only, no commercial use