

NC400 Definitive performance class D amp for DIY



Highlights

- Unprecedentedly low distortion over frequency and power range
- Unprecedentedly low output impedance
- Very low noise
- Neutral and transparent reproduction: "Neither dirt nor fairy dust"

Features

- Fully discrete signal path – no IC's
- Differential audio input
- Flexible power supply arrangement
- 22A current capability
- Extensive, microprocessor-controlled error protection
- Low weight: 185g.
- Compact: ø 88 x 37mm

Applications

- No-compromise power amp module for audiophile DIY projects
- Active speakers, standalone power amps

Introduction

The NC400 amplifier module is an extremely high-quality audio power amplifier module which operates in class D. Not only does it offer a way for audiophile music reproduction to continue in an ever more energy-conscious world, its measured and sonic performance actually raises the bar for audio amplifiers of any description. Operation is based on a non-hysteresis 5th order self-oscillating control loop taking feedback only at the speaker output.

Contents

Highlights	1
Features	1
Applications	1
Introduction	1
Contents	2
1 Safety precautions	3
2 Electrical Specifications	4
2.1 Recommended Operating Conditions and Supply Currents	4
2.2 Absolute maximum ratings	4
2.3 Ncore Amplifier Specifications	5
2.4 Ncore Amplifier Audio IO Characteristics	6
2.5 Frequently asked numbers	6
3 Environmental Specifications	7
3.1 Heat dissipation	7
4 IO Specifications	8
4.1 nAMPON	8
4.2 nFatal	8
5 Connector Pinouts	9
5.1 Power input and error signal	9
5.2 Ncore Audio input	10
5.3 Loudspeaker Connector	10
6 Typical Performance Graphs	11
7 Dimensions	12
7.1 Drill pattern	13
8 Appendix I: Microprocessor functions	14
8.1 Firmware operation	14
8.2 Protection limits	14
8.3 Flowchart	15
9 Appendix II: Connection guidelines	16
9.1 Cable dressing	16
9.2 Input configuration	16
9.3 Acceptable wiring schemes for amplifier chassis	17
9.4 Vastly preferred balanced setup: XLR input	17
9.5 Acceptable unbalanced setup	18
10 Revisions	20
11 Disclaimer	20

1 Safety precautions

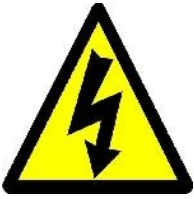

This module operates at high voltage and carries hazardous voltages at accessible parts. These parts may never be exposed to inadvertent touch. Observe extreme care during installation and never touch any part of the unit while it is connected to the mains. Disconnect the unit from the mains and allow all capacitors to discharge for 10 minutes before handling it.



Attention: Observe precautions for handling electrostatic sensitive devices. This module uses semiconductors that can be damaged by electrostatic discharge (ESD).

Damage due to inappropriate handling is not covered by warranty.

This product has no user-serviceable parts.



This symbol indicates the presence of hazardous voltages at accessible conductive terminals on the board. Parts that are not highlighted in red may also carry voltages in excess of 150 Vdc!

Warning: To reduce the risk of fire or electric shock, do not expose this apparatus to rain or moisture.

1. Read these instructions.
2. Keep these instructions.
3. Heed all warnings.
4. Follow all instructions.
5. Do not use this apparatus near water.
6. Protect the power cord from being walked on or pinched, particularly at plugs, convenience receptacles, and the point where they exit from the application.
7. Only use attachments/accessories specified or approved by the manufacturer.
8. Unplug this apparatus during lightning storms or when unused for long periods of time.
9. Refer all servicing to qualified service personnel. Servicing is required when the apparatus has been damaged in any way, liquid has been spilled or objects have fallen into the apparatus, the apparatus has been exposed to rain or moisture, does not operate normally or has been dropped.
10. Don't run any cables across the top or the bottom of the module. Apply fixtures to cables to ensure that this is not compromised.
11. Observe a minimum clearance of 6mm with all possible conducting parts (housing etc.).
12. Natural convection should not be impeded by covering the module (apart from the end applications housing).
13. This product is to be used with Hypex SMPS modules only.
14. Before using this product, ensure all cables are correctly connected and the power cables are not damaged. If you detect any damage, do not use the product.
15. Changes or modifications not expressly approved by Hypex Electronics will void compliance and therefore the user's authority to operate the equipment.
16. Service or modifications by any person or persons other than by Hypex Electronics authorized personnel voids the warranty.

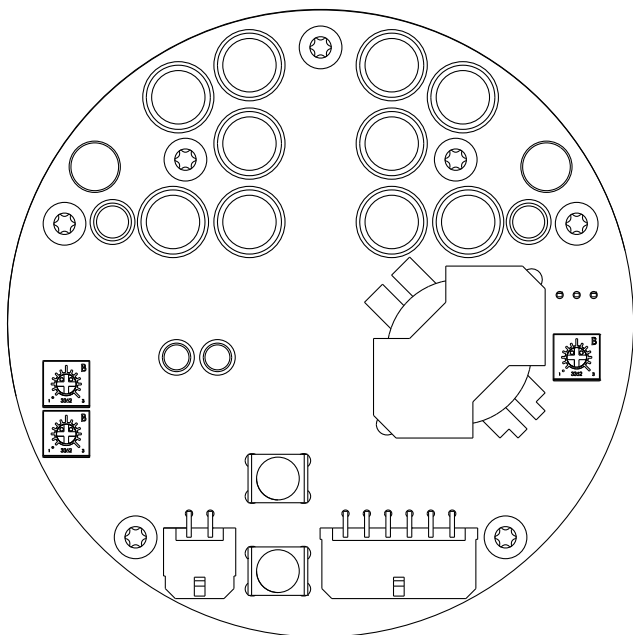

2 Electrical Specifications

2.1 Recommended Operating Conditions and Supply Currents

Parameter		Symbol	Min	Typ	Max	Unit	Note
Input Voltage Main	Symmetric supply (+/-)	HV	35	64	75	V	1)
Input Voltage Vaux (Signal stage supply)	Symmetric supply (+/-) Formerly Vsig.	Vaux	16		25	V	1)
Input Current Vaux	Formerly IVsig.	Iaux		40		mA	
External driver supply voltage	Below 16V the internal regulator takes over.	VDR		16	25 ¹⁾	V	2)
Drive supply current		IDR		70 ²⁾		mA	3)
Load impedance		ZLOAD	1			Ω	
Source impedance	For rated noise performance, otherwise higher is fine	ZSRC			1	kΩ	
Effective power supply storage capacitance	Per rail, per attached amplifier. 4Ω load presumed.	CSUP	4700			μF	4)

Note 1: Unit protects if allowable range is exceeded.

Note 2: This voltage is not monitored. Either use a floating supply or leave unconnected. Under no circumstance should this pin be connected to GND or to a supply that references ground.

Note 3: This current will either flow through VDR and HV- or through GND and HV-, depending on whether sufficient voltage is available at VDR.

Note 4: The effective power supply storage capacitance of a Hypex SMPS is already in excess of 4700uF. Do not add supplementary capacitance.

2.2 Absolute maximum ratings

Correct operation at these limits is not guaranteed. Operation beyond these limits may result in irreversible damage.

Parameter	Conditions	Symbol	Max	Unit	Note
Power supply voltage	See section 8.2	V _B	+/-75	V	
VDR supply voltage	See section 8.2	V _{DR}	25	V	
Peak output current	Guarded by current limit at 22A	I _{OUT,P}	25	A	
Input voltage	Either input referenced to ground	V _{IN}	+/-15	V	
Input current	Logical inputs and buffer inputs	I _{IN}	10m	A	
Collector voltage	Open collector outputs when high	V _{OC}	35	V	
Collector current	Open collector outputs when low	I _{OC}	2m	A	

2.3 Ncore Amplifier Specifications

Power supply = SMPS600, Load=4Ω, MBW=20kHz, Source imp=40Ω, unless otherwise noted

Parameter	Conditions	Symbol	Min	Typ	Max	Unit	Note
Peak Output Power	1KHz, THD=1%.	$P_{R, 2\Omega}$	-	580	-	W	
		$P_{R, 4\Omega}$	-	400	-	W	
		$P_{R, 8\Omega}$	-	200	-	W	
Distortion	20Hz<f<20kHz, 4Ω Pout<PR/2	THD+N, IMD ¹⁾	-	0.00 07	0.00 2	%	¹⁾
CMRR	All frequencies		-	55	-	dB	
Signal-to-Noise ratio (unweighted)		SNR	124	125		dB	
		SNR	101	102		Db	
Output Noise	Unweighted	U_N	-	23	25	μV	
Output Impedance	f<16kHz	Z_{OUT}		0.6	1	mΩ	
	f<20kHz				2.5	mΩ	
Power Bandwidth		PBW	35			kHz	²⁾
Frequency Response	+0/-3dB. All loads.		0		50	kHz	
Voltage Gain		A_v	25.3	25.8	26.3	dB	
Output Offset Voltage		$ V_{OO} $			50	mV	
Supply Ripple Rejection	Either rail, f < 1 kHz.	PSRR	75	80		dB	
Efficiency	Full power	η		93		%	
Idle Losses	External VDR	P_0		4.5	5	W	
Current Limit	Hiccup mode after 200ms limiting		21	22	23	A	

Note 1: At higher audio frequencies there are not enough harmonics left in the audio band to make a meaningful THD measurement. High frequency distortion is therefore determined using a 18.5kHz+19.5kHz 1:1 two-tone IMD test.

Note 2: Dielectric losses in the output capacitor limit long term (>30s) full-power bandwidth to 15kHz.

2.4 Ncore Amplifier Audio IO Characteristics



Parameter	Conditions	Symbol	Min	Typ	Max	Unit	Note
Input Impedance	Differential Mode	Z _{IN,DM}		104		kΩ	
	Common Mode	Z _{IN,CM}		1.5		MΩ	
Bias current	Inputs shorted together, sum measured to GND	I _{CM}		+/- 200		nA	
Offset current		I _{DM}		+/-3		nA	
Loudspeaker impedance range		Z _{L,SE}	2	4	-	Ω	

Signal Coupling

To achieve optimal signal coupling, the audio signal inputs are all DC coupled. One must make sure that the connected application is free of DC offset.

Input sensitivity

Below a formula is given to calculate the balanced input signal level for a desired output level. Furthermore an example is given using P_{RATED} 400W, Load 4Ω, Gain 25.8

$\frac{\sqrt{P_{RATED} * \Omega_{LOAD}}}{10^{\left(\frac{Gain}{20}\right)}} = Input V_{RMS}$	$V_{RMS} * \sqrt{2} = Input V_{Peak}$	$20 * \log_{10} \left(\frac{V_{RMS}}{0.7746} \right) = Input dBu$
		
$\frac{\sqrt{400 * 4}}{10^{\left(\frac{25.8}{20}\right)}} = 2.05 V_{RMS}$	$2.05 * \sqrt{2} = 2.90 V_{Peak}$	$20 * \log_{10} \left(\frac{2.05}{0.7746} \right) = 8.46 dBu$

2.5 Frequently asked numbers

The following are neither specifications nor indicators of audio performance but fundamental design choices which in combination with the specific circuit topology lead to the outstanding performance of the NC400. They do not influence sound quality directly. Commonly expressed creeds that an amplifier's suitability for high quality audio can be read from these numbers (f_{sw} in particular) are ill informed.

Parameter	Conditions	Symbol	Min	Typ	Max	Unit	Note
Switching frequency	Idle, see the white paper.	f _{sw}	470	480	530	kHz	
MOSFET ON resistance	Over tolerance and temperature	R _{DS(on)}		36	82	mΩ	
Dead time	"Soft" dead time. Effective value depends on load current	t _b		30		ns	
Output coil inductance	Effective output inductance is this number divided by loop gain.	L	9	10	11	μH	
Output coil resistance		R _L			3	mΩ	
Output capacitance		C	1.8	2.0	2.2	μF	
Loop gain	Loop gain peaks at 15kHz and drops back to 56dB at 20kHz.	A _L	55	56	62	dB	

3 Environmental Specifications

Parameter	Conditions	Symbol	Min	Typ	Max	Unit	Note
Ambient Temperature	Storage		5	-	70	°C	
	Operation	T_{amb}	5	-	65	°C	1)
Heat-sink Temperature		$T_{h,max}$			90	°C	2)
Humidity	Max 85 percent relative humidity, non-condensing.						

Note 1: Lower improves lifetime

Note 1: Thermistor limited. User to select heat sink to insure this condition under most adverse use case.

3.1 Heat dissipation

Class D amplifiers' known high efficiency often leads to a gross underestimation of the cooling required. The amount of cooling needed by the NC400 varies with usage. Please apply adequate cooling to the module to ensure the module operates within specification. The following graphs provide an indication of the heat (in Watts) generated at different output levels, provided that V_{dr} is supplied.

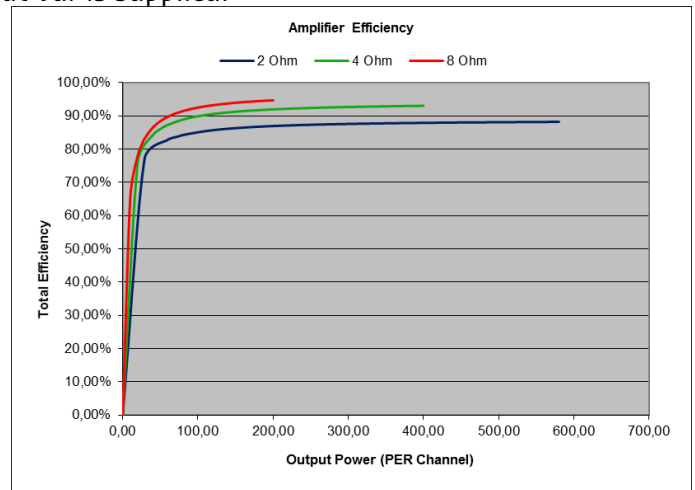
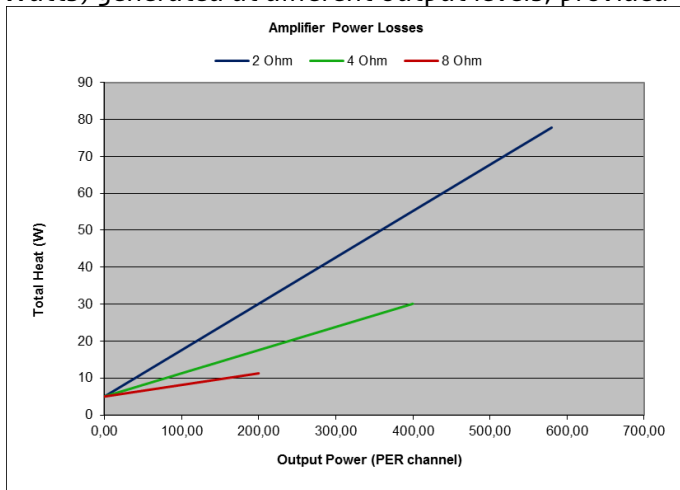

If your power supply includes a gate drive supply (V_{DR} , referenced to HV-), as the SMPS600 does, idle dissipation is around 4.5W. When no drive supply is available, another 5W are being dissipated by the on-board regulator.

Working out how much average power you need and the required cooling:

Music, or even pink noise, has a large peak-to-average ratio, so most of the available amplifier power is used as headroom. Audiophile listening is typically carried out at a few Watts at most with only the occasional full scale peak. On the other hand, when during a party hyper-compressed modern pop music is turned up until occasional clipping is heard, the average level may well reach 1/3rd of rated output. Nevertheless, agency standards such as EN60065 only call for a continuous power capability of 1/8th of rated output. Given are three examples, assuming a Δt of 45Kelvin:

- Normal: Design for 50W continuous output, translating to $P_{loss} = 4.5 + 0.06 * 50 = 7.5W$.
Required heatsinking is = $45K / 7.5W = 6 K/W$.
- Intensive use: Design for 133W, translating to $P_{loss} = 4.5 + 0.06 * 133 = 12.5W$.
Required heatsinking is = $45K / 12.5W = 3.6 K/W$.
- Minimal: Design for a few Watts, making the P_{idle} predominant and therefore: $P_{loss} \approx P_{idle}$
Required heatsinking is = $45K / 4.5W = 10 K/W$.

As it happens, the NC400 without additional cooling has a thermal resistance of around 6K/W. This indicates that free-air cooling is an option in most cases, at least provided that a power supply with V_{DR} output is used. It also indicates that any normal metal enclosure will provide enough additional cooling for even very heavy use.

For more information regarding cooling, please refer to our application note "Thermal Design", available on our website. Defects caused by overheating due to poor thermal management are not covered by warranty.

4 IO Specifications

Parameter	Notes	Symbol	Min	Typ	Max	Unit	Note
Pull-up	To 3.3V	R _{WPU}		27		kΩ	
Logical high input voltage	nAMPON, SCL, SDA	V _{IH}	2.65		3.6	V	
Logical low input voltage	nAMPON, SCL, SDA	V _{IL}	-0.3		0.5	V	
Logical high leakage current	FATAL	I _{OH}			1	μA	
Logical low output voltage	FATAL, I _{OL} =1mA	V _{OL}			0.4	V	

4.1 nAMPON

By connecting or pulling this pin to ground, the NC400 will automatically enable as soon as all error conditions have been cleared for at least two seconds. This pin can also be connected to an open collector output, so that external circuitry can control the NC400's state.

Parameter	Conditions	Symbol	Min	Typ	Max	Unit	Note
Amplifier in standby			2.65		3.6		1)
Amplifier enable			-0.3	GND	0.5		2)

Note 1: It is best practice to use a transistor output to pull nAMPON low and leave this pin floating (open collector) to switch the NC400 in standby mode.

Note 2: Pulling nAMPON low enables the amplifier as soon as all error conditions have been cleared for at least two seconds.

4.2 nFatal

Catastrophic fault indication, inverse of internal FATAL bit.

If a DC component is present at either of the speaker outputs, the nFatal pin will be pulled low. If used in combination with the SMPS600, this triggers the SMPS to switch off immediately. To reset the DC Error the setup must be disconnected from mains for at least 10 minutes to allow the primary capacitors to drain.

Parameter	Conditions	Symbol	Min	Typ	Max	Unit	Note
Collector voltage	Open collector output		-	-	50	V	
Collector current	Open collector output		-	-	100	mA	

5 Connector Pinouts

This chapter describes the functional connectors of the amplifier module. A connector not stated in this chapter is only used for production or quality control and must remain unconnected in the end user appliance.

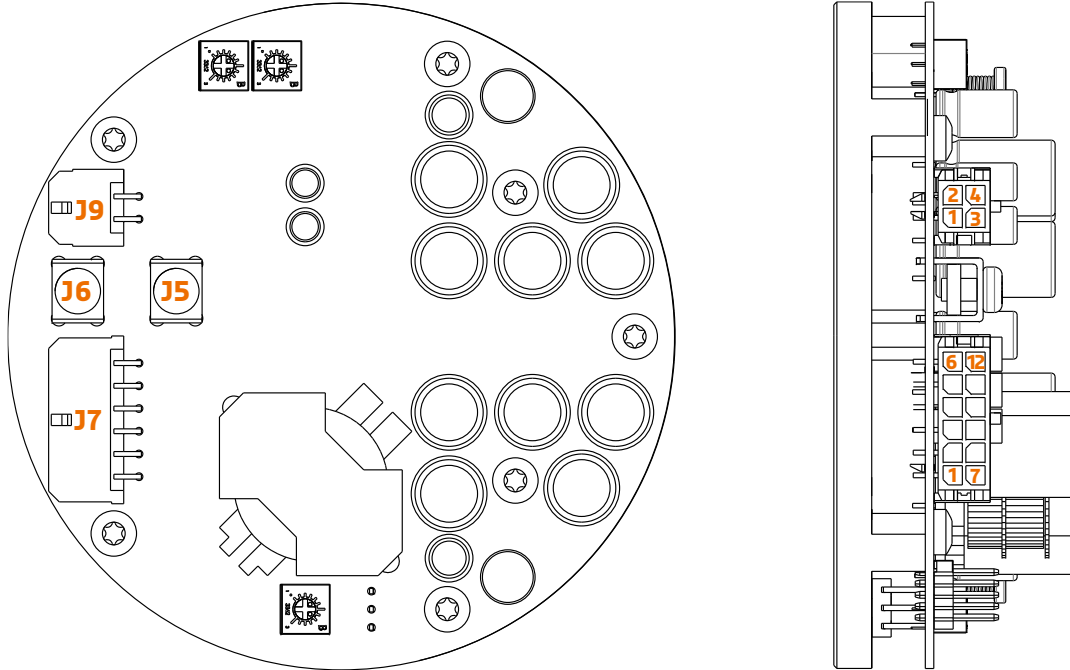

5.1 Power input and error signal

Pin	Direction	Function	Remarks
J7.1	Input	HV +	Positive power supply
J7.2	Input	HV +	Positive power supply
J7.3	-	GND	Ground
J7.4	-	GND	Ground
J7.5	Output	Error indication	See section 4.2 nFatal
J7.6	Input	Vaux +	Positive supply for op amps. (Formerly Vsig+)
J7.7	Input	HV -	Negative power supply
J7.8	Input	HV -	Negative power supply
J7.9	-	GND	Ground
J7.10	-	GND	Ground
J7.11	Input	VDR	VDR power supply
J7.12	Input	Vaux -	Negative supply for op amps. (Formerly Vsig-)

Connector type: Molex Microfit header type 43045-1200. Mates with 43025-1200 cable part.

5.2 Ncore Audio input

Pin	Direction	Function	Remarks
J9.1	Input	INH (+)	Non-inverting audio input
J9.2	Input	INC (-)	Inverting audio input
J9.3	Input	nAMPON	See section 4.1 nAMPON
J9.4	-	GND	Ground

Connector type: Molex Microfit header type 43045-0412, Mates with 43025-0400 cable part.

The audio input is differential. This means that ground is not part of the audio signal. When connecting an unbalanced source, treat pins 1 and 2 as a floating input with pin 2 being the “audio ground” of the source. Pin 4 may be used to attach the shield of a shielded twisted pair cable, but the “audio ground” connection of an unbalanced source should never connect here.

5.3 Loudspeaker Connector

Pin	Direction	Function	Remarks
J5	-	LS1-	Cold Loudspeaker Output
J6	Output	LS1+	Hot Loudspeaker Output

Connector type: Screw terminal.

Custom gold-plated screw tags. Insert bare wire between the mobile square nut and the fixed part. The positive output is J6, the one nearest the edge of the circuit board. Note: the output impedance of the NC400 is very low, allowing you to maximize the benefit of biwired configurations by starting both cable runs from the screw tags. It is very important to use twisted pairs for the output cabling, at the very least anywhere near the PSU cabling. The distortion of the NC400 is so low that it is easily exceeded by magnetic coupling between the supply wiring and the audio wiring.

6 Typical Performance Graphs

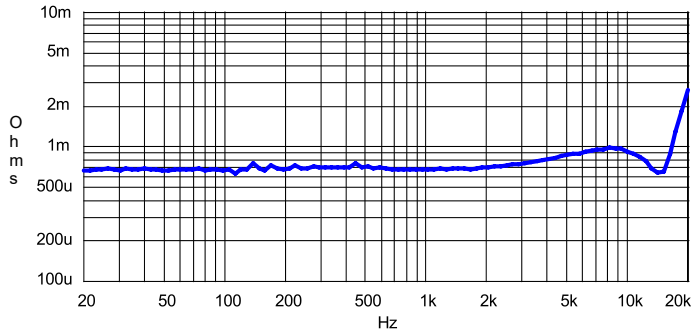

Output impedance, four-wire test at speaker terminals.

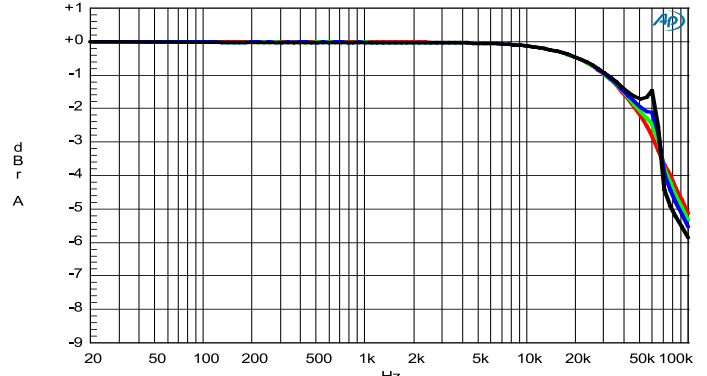

Frequency response in 2Ω (black), 4Ω (blue), 8Ω (green), open circuit (red).

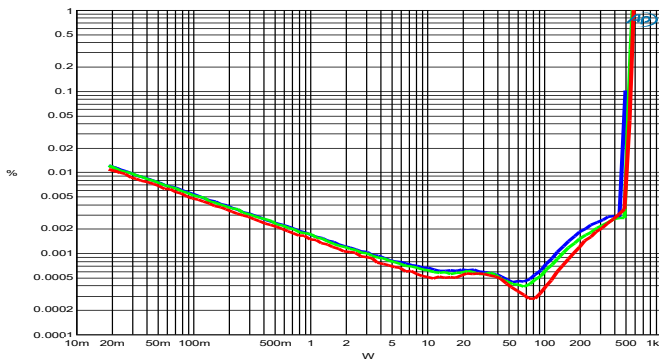

THD+N vs. power at 100Hz (blue), 1kHz (green) and 6kHz (red) (2Ω).

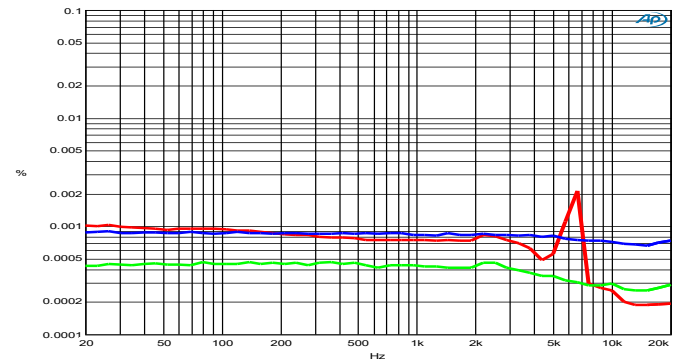

THD vs. frequency at 2W (blue, dominated by noise), 20W (green) and 200W (red)

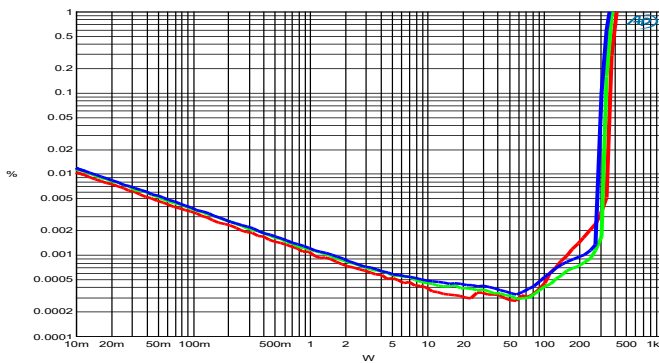

THD+N vs. power at 100Hz (blue), 1kHz (green) and 6kHz (red) (4Ω).

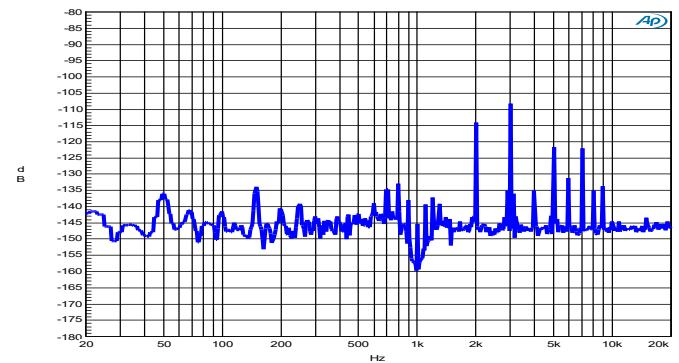

Distortion residual at 200W, 1kHz.

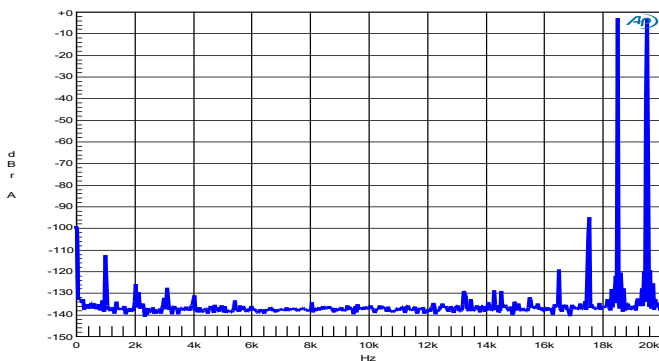

IMD spectrum at 18.5kHz+19.5kHz, 100W+100W into 2 ohms.

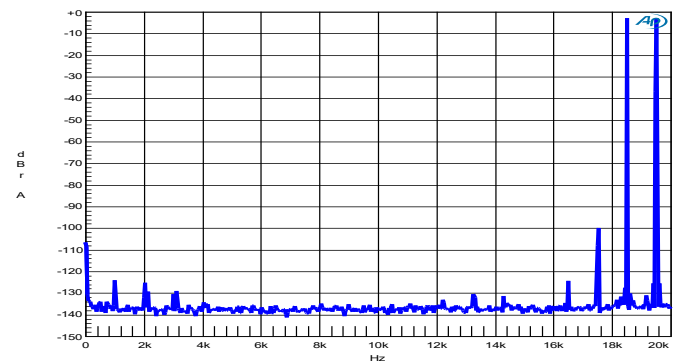

IMD spectrum at 18.5kHz+19.5kHz,

Peak voltage corresponds to a 400W sine.

50W+50W. Peak voltage corresponds to a 200W sine.

7 Dimensions

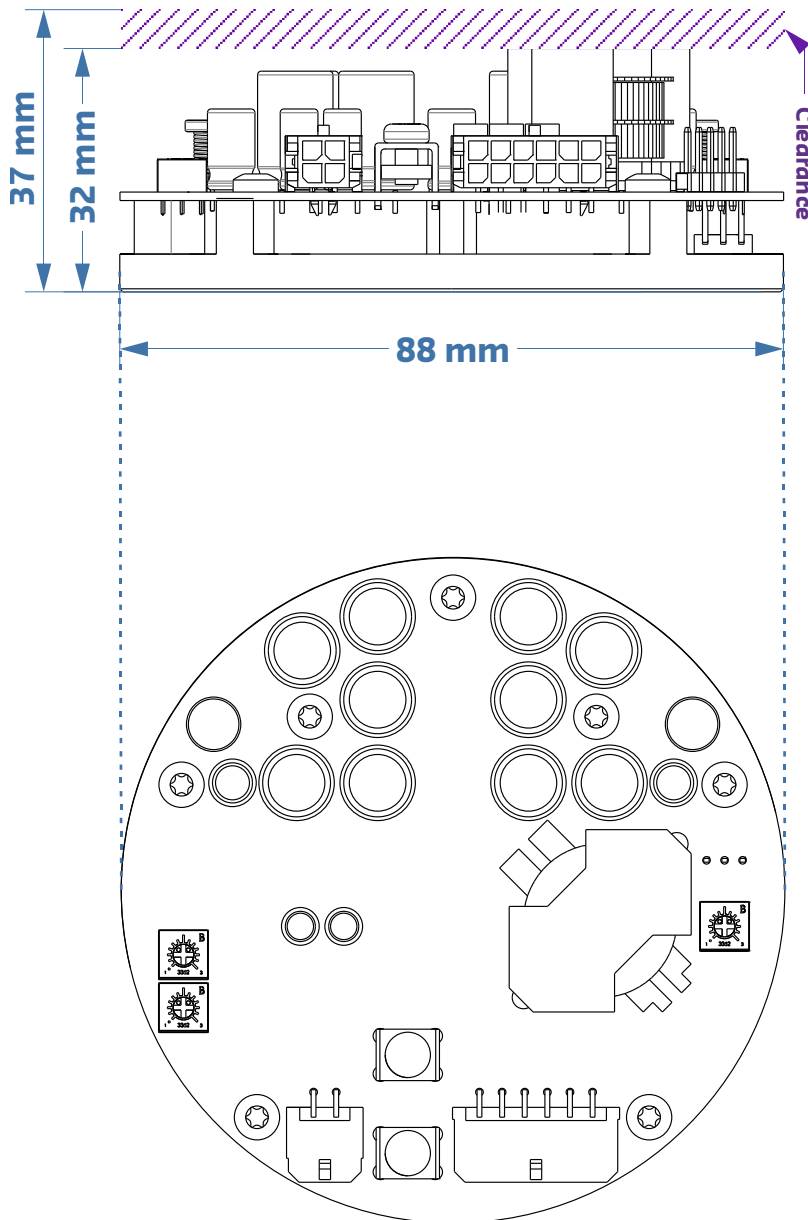

7.1 Drill pattern

If printed correctly (scale 100%, A4), the scale of the image below should be 1:1. You may use it as a model to drill holes in your casing. Please verify before drilling!

Bottom-up mounting

Normal mounting proceeds through three tapped holes in the bottom of the plate. Maximum allowed protruding depth inside each hole is 4mm. Three countersunk M3 screws are included.

Top-down mounting

Occasionally it may be desirable to bolt the module down from the inside of the chassis into blind tapped holes such as to avoid having any screws visible from the outside. Three of the screws holding the module together are fixed with nuts instead of threaded holes (marked 'B' in the mechanical drawing). Remove these three and save them together with the nuts. Replace them by 20mm M3 screws (included) to mount the module.

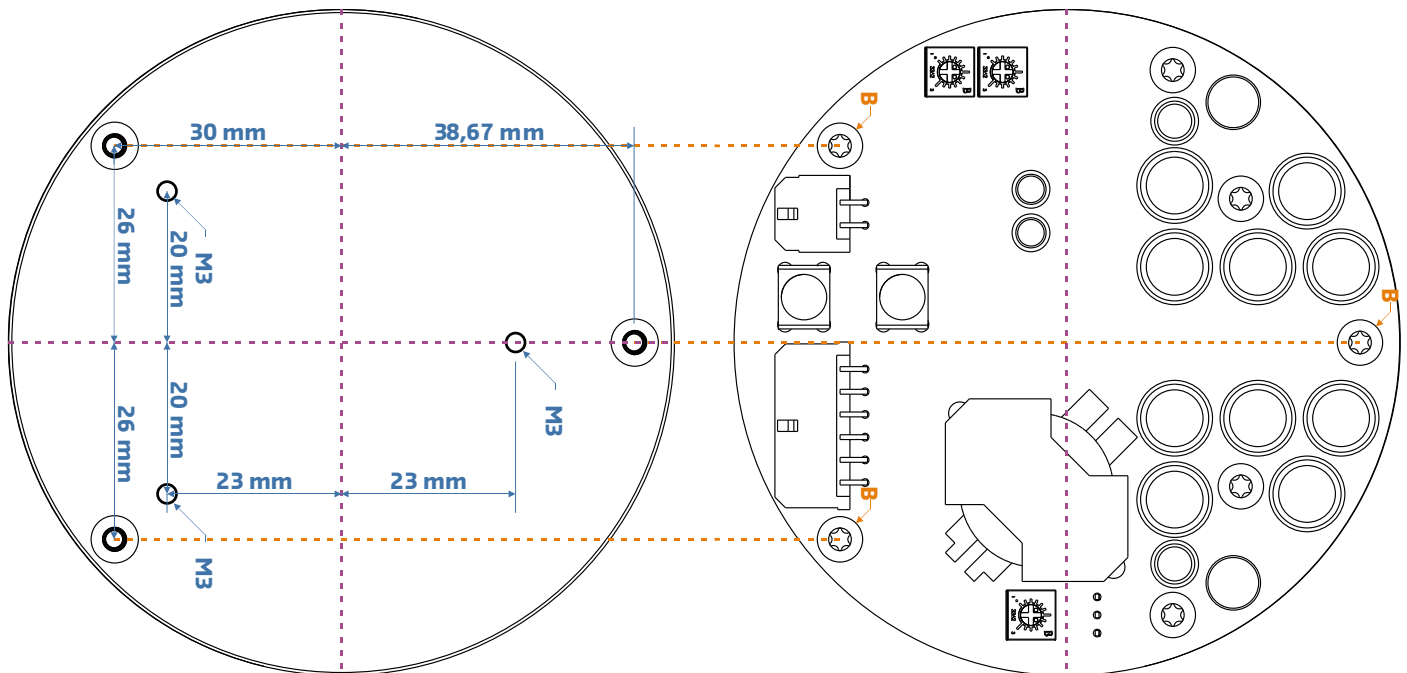

8 Appendix I: Microprocessor functions

Important notice: the microprocessor functionality cannot be custom-tailored and should not be tampered with. Source code will not be made available.

8.1 Firmware operation

The microprocessor has three main functions:

- to provide an interface for controlling the amplifier
- to monitor the supply voltages in order to prevent spurious operation during power up/down
- to detect error conditions.

Most errors clear automatically as soon as the error condition lifts. The exception is a fatal DC fault. When a large DC output is detected, the amplifier first shuts down to be able to differentiate between an actual power stage breakdown and a DC condition caused by DC at the audio input. If the error persists, the FATAL line is asserted (pulled down) to turn the power supply off. If the error goes away the amplifier turns back on.

8.2 Protection limits

Parameter	Conditions			Typ		Unit	Note
HV+/-	under voltage			35		V	
	over voltage			75		V	
V _{DR}	under voltage			13.5		V	1)
	over voltage			16		V	
Temperature	Over temperature			95		°C	
	lower hysteresis			85		°C	

Note 1: The internal V_{DR} regulator makes this error condition unlikely

8.3 Flowchart

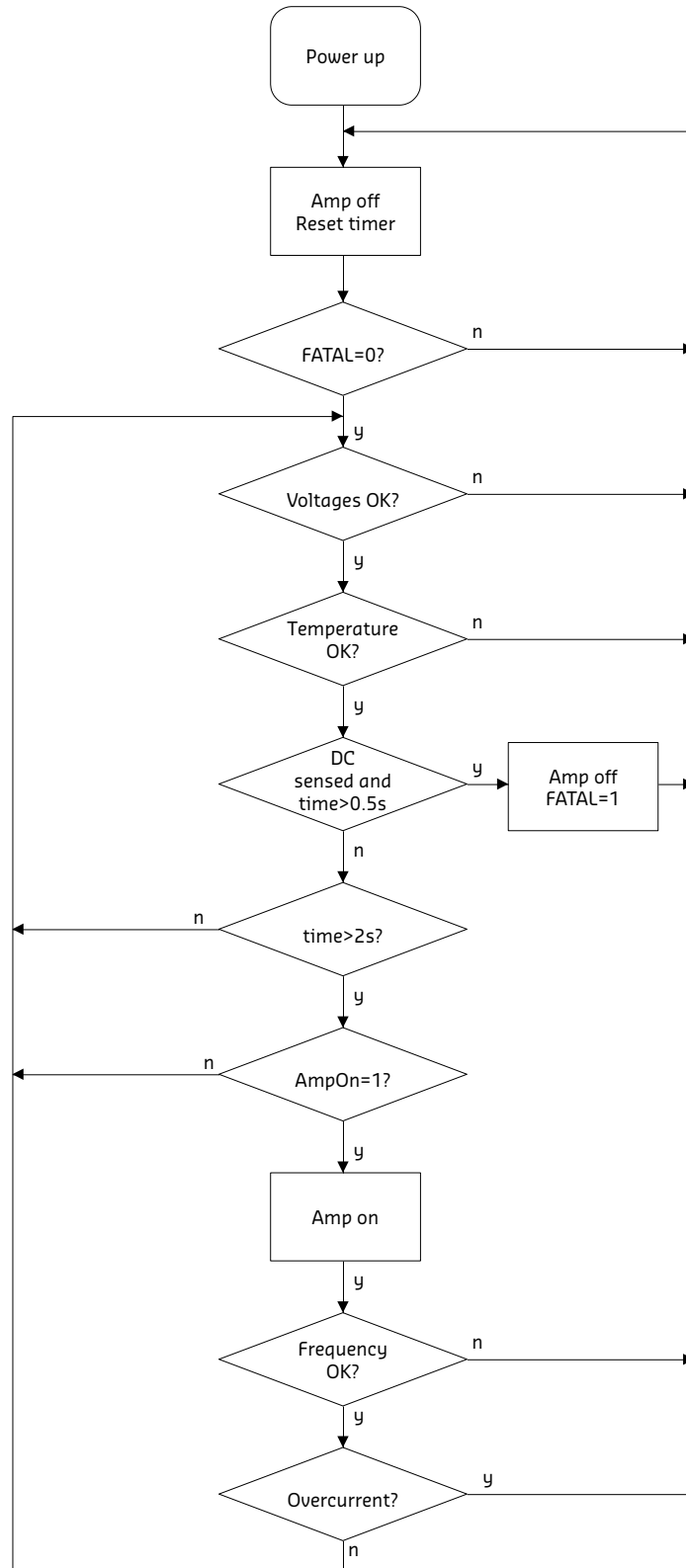

9 Appendix II: Connection guidelines

Please refer to chapters 4 *IO Specifications* and 5 *Connector Pinouts* before reading this appendix.

9.1 Cable dressing

The NC400 module has exceedingly low distortion. This makes it very easy for extraneous causes to add much more distortion and colouration than the amplifier itself. The first major cause of such distortion is direct magnetic crosstalk from the supply cable into the audio input or the loudspeaker output. This is minimized in several ways:

- Run the audio and power supply cables away from each other.
- Tie-wrap the supply cable to form a tight bunch.
- Tightly twist all loudspeaker cabling inside the chassis.

9.2 Input configuration

The second major cause of extraneous noise and distortion is common-impedance coupling between power wiring and signal connections. This is caused by the use of ground-referenced signalling (aka single-ended or unbalanced transmission), which unfortunately is the predominant method of interfacing consumer-grade audio equipment. As a result the ground circuit becomes an inseparable part of the signal path and any currents flowing through the ground circuit affect the audio signal.

Ground loops cannot fundamentally be avoided. Star grounding only works at low frequencies. The longer the wires to the “star”, the lower the frequency at which supply decoupling becomes ineffective. The maximum permissible trace length of decoupling capacitors in class D amplifiers is measured in millimetres and the value of the decoupling capacitances is large. To make a long story short: you cannot connect the audio signal using a single wire and hope to solve the ensuing drama using star grounding. It won't work.

The solution adopted by the NC400 is a floating input, consisting of a “hot” and a “cold” connection, which can be connected to the source like the primary of an isolation transformer. This breaks any current flow that might otherwise flow in the audio cable. You would **never** directly connect the cold pin of the input connector to the ground pin in the same way as you would never locally ground input of an isolation transformer because it would no longer provide isolation.

Note that this isolation is not absolute. Differentials of more than a few 100mV should be avoided. Because of this, some current path should be provided using a third wire. Any current that flows through that wire is current that's no longer flowing through your audio cable, and which is now harmless.

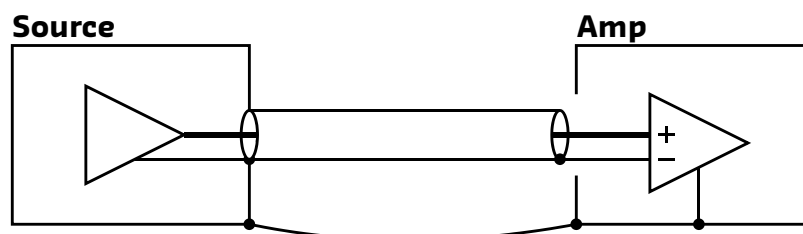

Figure 1: The basic idea behind a differential (floating) input.

9.3 Acceptable wiring schemes for amplifier chassis

The differential input permits a wide range of robust scenarios for hum-free connection, of which three will be shown. We would like to urge users not to venture into the unknown before having tried one of the proven good ones.

9.4 Vastly preferred balanced setup: XLR input.

Regardless of whether the remainder of your audio system has balanced connections or not, the very best way to wire the input of the NC400 is to leverage the advantage of its balanced input. You can get almost all of the quality improvement afforded by balanced connections even with an unbalanced source, provided that you have a balanced input.

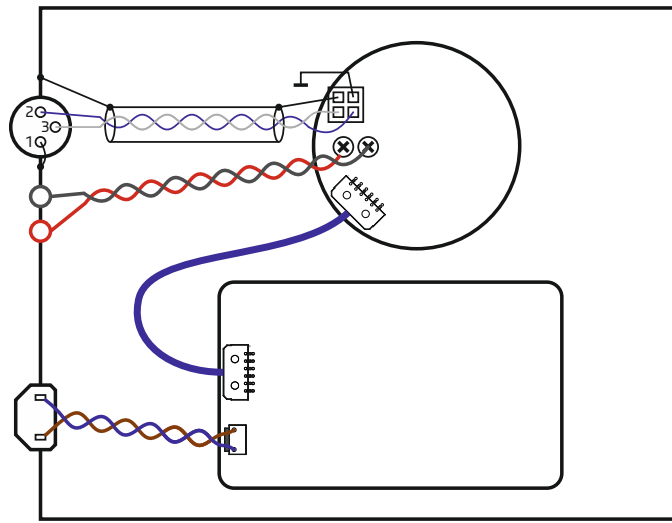

Figure 2: Example preferred connection with SMP5600

The input cable included with the module is a high-quality shielded twisted-pair (microphone) cable. By convention the input connector is a female XLR. How this benefits systems that already use balanced connections is obvious. Importantly though, it benefits unbalanced setups almost equally. This is how it works:

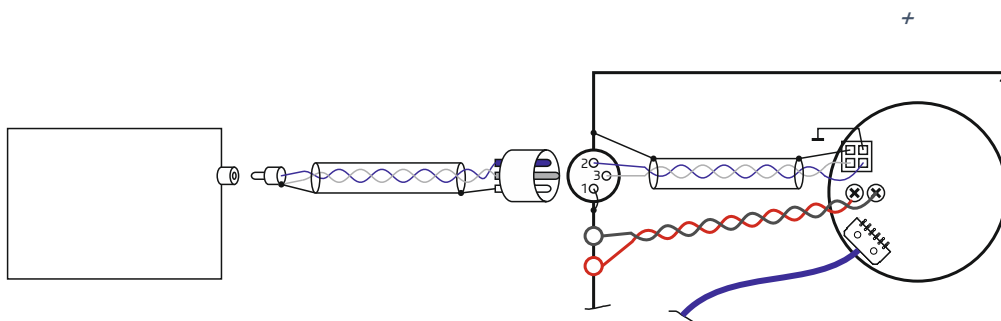

Figure 3: How to benefit from a balanced input even if the source is unbalanced

This is the concept described in “9.2 Input configuration”, done in a practical way. A microphone cable is terminated on the source end with an RCA connector and with a male XLR connector on the destination end. The output signal is the voltage difference between the RCA pin and the RCA shell. Since the cold (white) wire is not used to carry ground currents, the amplifier does indeed see the exact output voltage of the source. Assuming that the RCA shell on the source is bonded to the chassis, we can safely connect the shield wire there as well. The braided cable shield serves two duties: to connect the chassis potentials together and to shield electrostatically the signal. No safety earth connection was depicted. This is entirely acceptable if class II construction is used throughout. Otherwise, connect the safety earth. For more information, please refer to our application notes.

9.5 Acceptable unbalanced setup

Having made sufficiently clear that there is, in fact, no reason why anyone should ever want to waste a perfectly good balanced input by putting the module in a box with RCA inputs, it is likely that some will persist. Two workable methods are given. The first uses differential wiring up to the rear panel to present a normal unbalanced input to the outside world, the second uses an unbalanced cable as a floating quasi-differential connection.

Acceptable unbalanced setup 1: floating chassis and bonded RCA inputs

The first working method is the simplest. Use class II construction and use a 2-prong mains inlet. Use **uninsulated** RCA connectors and wire it to the NC400 input using the supplied cable using the two-wire-plus-shield method previously used for the RCA-XLR adapter cable. For clarity, a stereo system is shown. Important: place the 2 RCA connectors close together (25mm or so) and once again, bond them solidly to the chassis. What this arrangement does is prevent circulating currents from getting out into the two connected audio cables. Inside the chassis those currents do no harm because they do not flow through the audio wires.

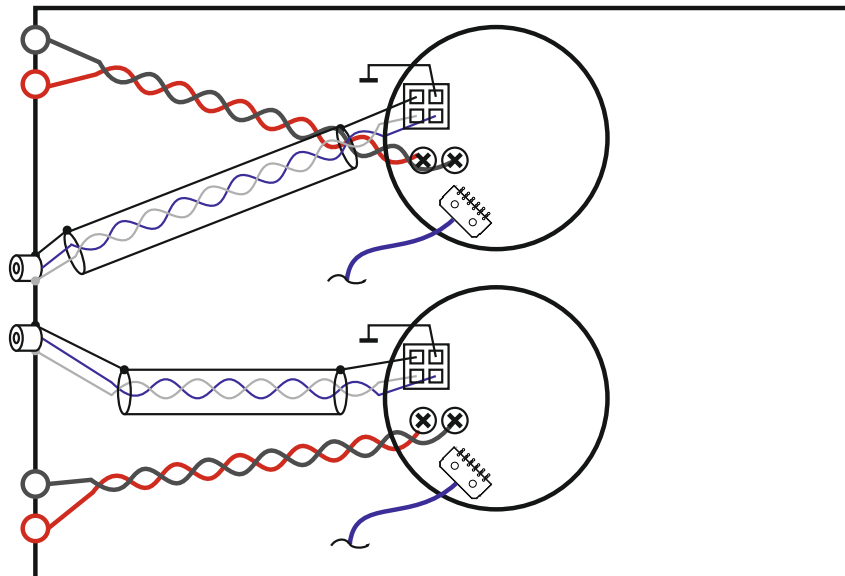

Figure 1: Unbalanced input with hard-bonded RCA's and no mains earth

Acceptable unbalanced setup 2: grounded chassis and semi-floating RCA inputs

Most hum problems are found in systems that use both mains earth and unbalanced inputs. A common workaround is lifting the secondary ground. In some cases this invites hum through capacitive coupling. And in the case of the NC400, short of insulating the whole module the secondary ground cannot be lifted from the chassis. A much better solution is to lift only the input, which you can do when you have an actual difference amplifier at your disposal. The allowable common mode range is not infinite though, so the RCA ground cannot be fully floated. Nevertheless, the added noise rejection when interfacing with other grounded unbalanced kit is substantial.

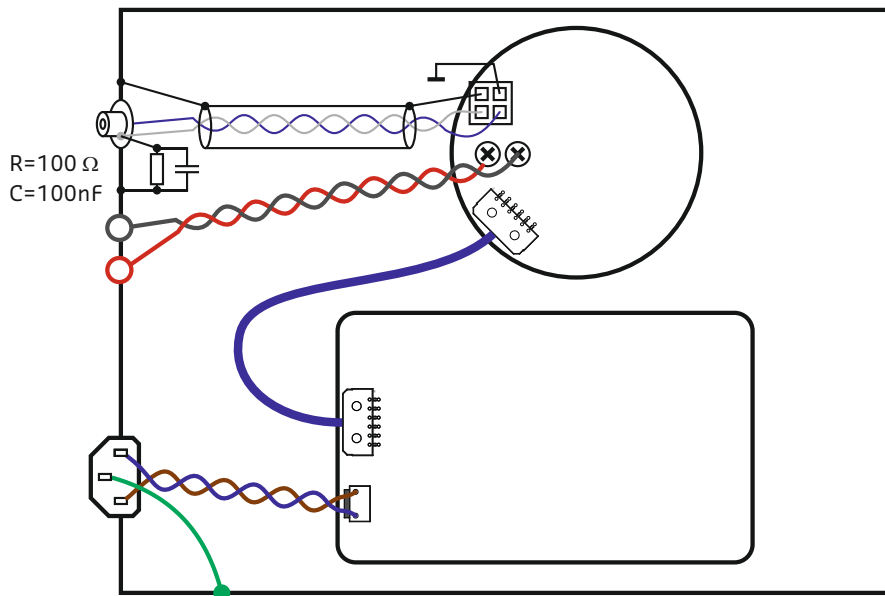

Figure 2: Solution if both mains, protective earth and RCA inputs are wanted

It should be stressed that the problems concerning unbalanced connections that were outlined here are not related to the amplifier, but are inherent to the very phenomenon of unbalanced connections. The reason why they are being highlighted is precisely because thanks to the presence of a differential input, they can be solved without having to resort to esoteric grounding arrangements.

10 Revisions

Document revision	Module revision	Change log	Date
R1	NC400 01xx	Added wiring instructions, removed the "preliminary" tag	December '11
R2	NC400 01xx	Expanded firmware section. Added offset voltage spec.	January '12
R3	NC400 01xx	Fixed labeling error on THD vs F graph	July '12
R4	NC400 03xx	Signal cable colours changed to match new cable type	January '13
01	NC400 04xx	Format changed to new standard Drawings updated Multiple explanations clarified Output current corrected. Generally applicable information moved to appendixes	July '16

11 Disclaimer

All products, product specifications and data are subject to change without notice to improve reliability, function or design or otherwise.

Hypex Electronics BV, its affiliates, agents, and employees, and all persons acting on its or their behalf (collectively, "Hypex Electronics"), disclaim any and all liability for any errors, inaccuracies or incompleteness contained in any datasheet or in any other disclosure relating to any product.

This subassembly is designed for use in music reproduction equipment only. No representations are made as to fitness for other uses. Except where noted otherwise any specifications given pertain to this subassembly only. Responsibility for verifying the performance, safety, reliability and compliance with legal standards of end products using this subassembly falls to the manufacturer of said end product.

LIFE SUPPORT POLICY: Use of Hypex products in life support equipment or equipment whose failure can reasonably be expected to result in injury or death is not permitted except by explicit written consent from Hypex Electronics BV.