



# Stereo valve power amplifier

For most of us a high power valve amplifier is unaffordable. This kit changes that, so that now everybody can enjoy that sublime "valve sound".

Total solder points: 700

Difficulty level: *beginner* 1  2  3  4  5  *advanced*



# K4040

**Features:**

- ☑ Pure valve sound with high quality EL34 valves.
- ☑ High quality black and chrome housing.
- ☑ Chrome valve socket covers.
- ☑ Easy bias adjustment with LED indication.
- ☑ Removable bottom for easy access and service.
- ☑ High quality capacitors and components.
- ☑ Gold plated input and speaker terminals.
- ☑ Standby function.
- ☑ Soft start circuit for power transformer.

**Specifications:**

- 2 x 90Wrms in 4 or 8W.
- Up to 2 x 15Wrms full class A.
- Bandwidth: 8Hz to 80KHz (-3dB/1W).
- Harmonic distortion: 0.1% @ 1W/1KHz.
- Signal to noise ratio: >105dB (A weighted).
- Input sensitivity: 1Vrms.
- 115VAC or 230VAC / 500VA max.

modifications reserved

**1. Assembly (Skipping this can lead to troubles !)**

Ok, so we have your attention. These hints will help you to make this project successful. Read them carefully.

**1.1 Make sure you have the right tools:**

- A good quality soldering iron (25-40W) with a small tip.
- Wipe it often on a wet sponge or cloth, to keep it clean; then apply solder to the tip, to give it a wet look. This is called 'thinning' and will protect the tip, and enables you to make good connections. When solder rolls off the tip, it needs cleaning.
- Thin raisin-core solder. Do not use any flux or grease.
- A diagonal cutter to trim excess wires. To avoid injury when cutting excess leads, hold the lead so they cannot fly towards the eyes.
- Needle nose pliers, for bending leads, or to hold components in place.
- Small blade and Phillips screwdrivers. A basic range is fine.

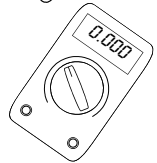
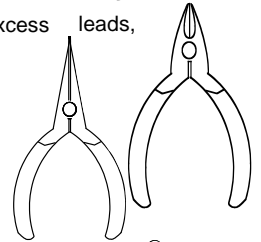
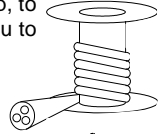
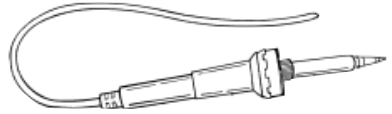

**For some projects, a basic multi-meter is required, or might be handy**

**1.2 Assembly Hints :**

- ⇒ Make sure the skill level matches your experience, to avoid disappointments.
- ⇒ Follow the instructions carefully. Read and understand the entire step before you perform each operation.
- ⇒ Perform the assembly in the correct order as stated in this manual
- ⇒ Position all parts on the PCB (Printed Circuit Board) as shown on the drawings.
- ⇒ Values on the circuit diagram are subject to changes.
- ⇒ Values in this assembly guide are correct\*
- ⇒ Use the check-boxes to mark your progress.
- ⇒ Please read the included information on safety and customer service
  
- ⇒ \* Typographical inaccuracies excluded. Always look for possible last minute manual updates, indicated as 'NOTE' on a separate leaflet.

**1.3 Soldering Hints :**

1- Mount the component against the PCB surface and carefully solder the leads

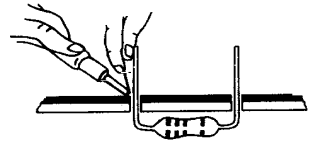

2- Make sure the solder joints are cone-shaped and shiny

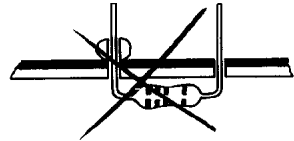
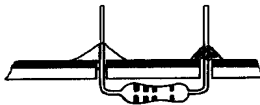

3- Trim excess leads as close as possible to the solder joint

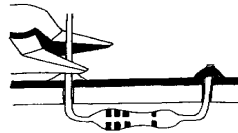

REMOVE THEM FROM THE TAPE ONE AT A TIME !

**AXIAL COMPONENTS ARE TAPED IN THE CORRECT MOUNTING SEQUENCE !**

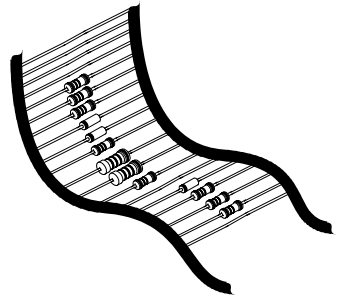

**Assembly of the small input PCB P4040i:**

This PCB is used to connect the input signal (via two RCA sockets) via two holes at the rear of the cabinet.

**1. Ceramic Capacitor**

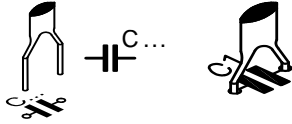

□ C1 : 47nF (473)

**2. CINCH / RCA connector**

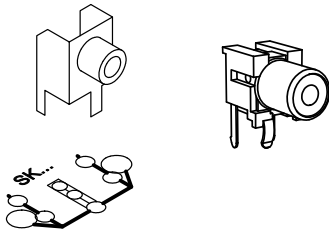

□ SK1 : CINCH  
 □ SK2 : CINCH

**3. Shielded wire connector**

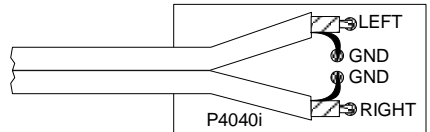
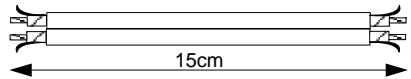
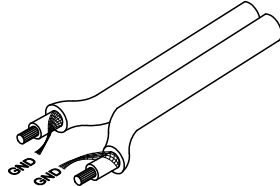

□ L  
 □ GND  
 □ R  
 □ GND

**Assembly of the main PCB P4040B:**

Because of the PCB dimensions, first mount the 8 large tube sockets so that the PCB can rest on a table, without the component leads being touched. When mounting the components, it is best to fold back the component leads a little before turning the PCB over to solder them.

**1. Valve socket mounting**

Check the position of the notch in the centre of the tube socket, it must correspond to the notch in the circle printed on the PCB. Connect the leads to the corresponding isle on the PCB using a small piece of jumper wire.

**IMPORTANT:**

Make the connection exactly as shown in the figure, otherwise the small piece of wire could touch the bottom of the cabinet.

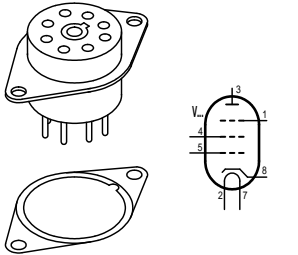

Also mount a 15 mm spacer on the remaining holes in the PCB (at the solder side), use a 6 mm M3 bolt:

- Two spacers round tube sockets V9 and V10
- A spacer next to RY3
- A spacer next to T2
- A spacer next to R1
- A spacer next to SW1, **together with a lock washer** at the solder side:

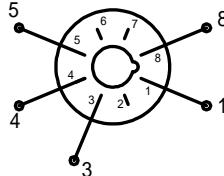
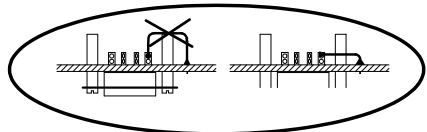
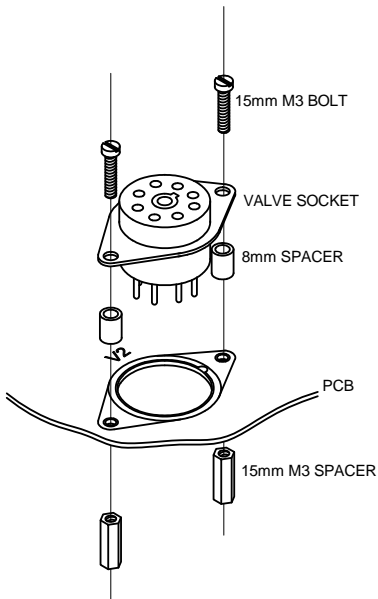
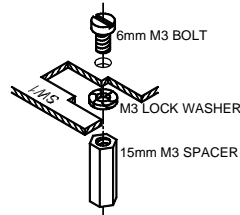

- |                                   |                                   |
|-----------------------------------|-----------------------------------|
| <input type="checkbox"/> V1: I.O. | <input type="checkbox"/> V5: I.O. |
| <input type="checkbox"/> V2: I.O. | <input type="checkbox"/> V6: I.O. |
| <input type="checkbox"/> V3: I.O. | <input type="checkbox"/> V7: I.O. |
| <input type="checkbox"/> V4: I.O. | <input type="checkbox"/> V8: I.O. |

Connect the valve socket terminals 1, 3, 4, 5, and 8 to the corresponding points at the solder side of the PCB. Use a piece of jumpwire but take care that the connection does not come above the spacer, otherwise, the wire could touch the housing later (see drawing above).

## 2. Jumpers.

☞ Note that from J1 to J6, two jumper leads have to be mounted in the same hole.

**TIP :** In order to get nice straight wiring, without too much folding and measuring, follow these hints:

- Mount the lead on the PCB as it is.
- Solder 1 end of the lead.
- Then carefully pull on the free end of the lead until it is straight.
- Now solder the other end.

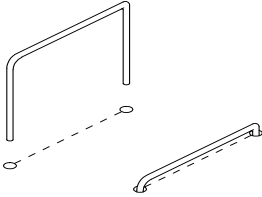

- J1 (2 wires)
- J2 (2 wires)
- J3 (2 wires)
- J4 (2 wires)
- J5 (2 wires)
- J6 (2 wires)
- J7
- J8
- J9
- J10
- J11
- J12
- J13
- J14
- J15
- J16
- J17
- J18
- J19
- J20
- J21
- J22
- J23
- J24
- J25
- J26

## 3. Jumpers for voltage selection

### MAINS VOLTAGE SELECTION:

For 100V mains input, mount:

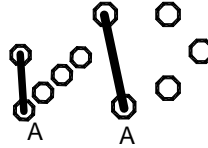

For 120V mains input, mount:

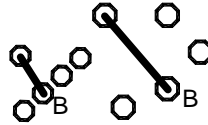

For 230V mains input, mount:

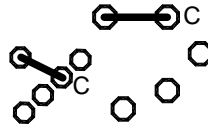

For 240V mains input, mount:

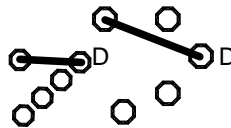

☞ **REMARK:** Strike out the NOT used mains voltage indication at the back of the housing !! e.g. cross out with a permanent black marker.

## 4. Diodes. Watch the polarity!

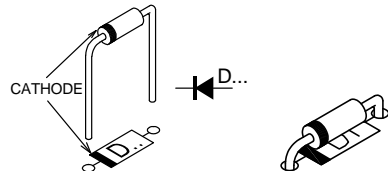

- D1 : 1N4148
- D2 : 1N4148
- D3 : 1N4007
- D4 : 1N4007
- D5 : 1N4007
- D6 : 1N4007

- D7 : 1N4007
- D8 : 1N4007
- D9 : 1N4007
- D10 : 1N4007

- D11 : 1N5408 **not on tape !**
- D12 : 1N5408 **not on tape !**
- D13 : 1N5408 **not on tape !**
- D14 : 1N5408 **not on tape !**

- D15 : **1N4148**
- D16 : **1N4148**
- D17 : 1N4007
- D18 : **1N4148**
- D19 : 1N4007
- D20 : 1N4007
- D21 : 1N4007
- D22 : **1N4148**
- D23 : **1N4148**
- D24 : **1N4148**
- D25 : **1N4148**
- D26 : 1N4007

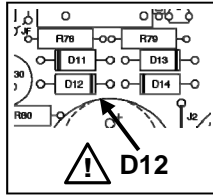

- R11 : 12K (1-2-3-B)
- R12 : 33K (3-3-3-B)
- R13 : 33K (3-3-3-B)
- R16 : 12K (1-2-3-B)
- R17 : 820K (8-2-4-B)
- R18 : 820 (8-2-1-B)
- R19 : 180 (1-8-1-B)
- R20 : 1M (1-0-5-B)
- R21 : 22K (2-2-3-B)
- R22 : 3K9 (3-9-2-B)
- R23 : 820K (8-2-4-B)
- R24 : 820 (8-2-1-B)
- R25 : 180 (1-8-1-B)
- R26 : 1M (1-0-5-B)
- R27 : 22K (2-2-3-B)
- R28 : 3K9 (3-9-2-B)
- R29 : 10K (1-0-3-B)
- R30 : 10K (1-0-3-B)
- R31 : 10K (1-0-3-B)
- R32 : 10K (1-0-3-B)
- R33 : 10K (1-0-3-B)
- R34 : 10K (1-0-3-B)
- R35 : 1K5 (1-5-2-B)
- R36 : 1K5 (1-5-2-B)
- R37 : 560 (5-6-1-B)
- R38 : 10K (1-0-3-B)
- R39 : 220K (2-2-4-B)
- R40 : 100K (1-0-4-B)
- R41 : 220K (2-2-4-B)
- R42 : 100K (1-0-4-B)
- R43 : 220K (2-2-4-B)
- R44 : 100K (1-0-4-B)
- R45 : 220K (2-2-4-B)
- R46 : 100K (1-0-4-B)
- R47 : 1K5 (1-5-2-B)
- R48 : 33K (3-3-3-B)
- R49 : 12K (1-2-3-B)
- R50 : 220K (2-2-4-B)
- R51 : 10K (1-0-3-B)
- R52 : 100K (1-0-4-B)
- R53 : 220K (2-2-4-B)
- R54 : 100K (1-0-4-B)
- R55 : 220K (2-2-4-B)
- R56 : 100K (1-0-4-B)
- R57 : 220K (2-2-4-B)
- R58 : 100K (1-0-4-B)

**5. Zener diodes. Watch the polarity!**

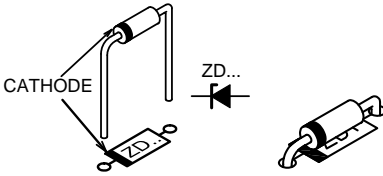

- ZD1 : 3V9
- ZD2 : 3V9

**6. 1/4W Resistors**

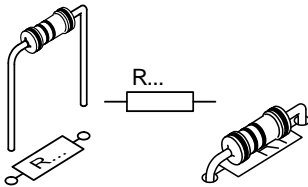

- R1 : 1K (1-0-2-B)
- R2 : 1K (1-0-2-B)
- R3 : 470 (4-7-1-B)
- R4 : 1K (1-0-2-B)
- R5 : 22K (2-2-3-B)
- R6 : 220K (2-2-4-B)
- R7 : 2K2 (2-2-2-B)
- R8 : 2K2 (2-2-2-B)
- R9 : 220K (2-2-4-B)
- R10 : 22K (2-2-3-B)

**7. Metal film resistors (1/2W)**

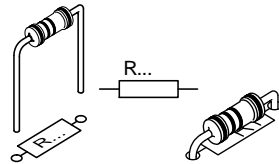

- R59 : 100K (1-0-4-B-9)
- R60 : 100K (1-0-4-B-9)
- R61 : 47K (4-7-3-B-9)



- R62 : 47K (4 - 7 - 3 - B - 9)
- R63 : 220 (2 - 2 - 1 - B - 9)
- R64 : 220 (2 - 2 - 1 - B - 9)
- R65 : 820 (8 - 2 - 1 - B - 9)
- R66 : 220 (2 - 2 - 1 - B - 9)
- R67 : 220 (2 - 2 - 1 - B - 9)
- R68 : 820 (8 - 2 - 1 - B - 9)
- R69 : 330K (3 - 3 - 4 - B - 9)
- R70 : 330K (3 - 3 - 4 - B - 9)
- R71 : 330K (3 - 3 - 4 - B - 9)
- R72 : 330K (3 - 3 - 4 - B - 9)
- R73 : 330K (3 - 3 - 4 - B - 9)
- R74 : 330K (3 - 3 - 4 - B - 9)
- R75 : 330K (3 - 3 - 4 - B - 9)
- R76 : 330K (3 - 3 - 4 - B - 9)

**8. 1W resistors**

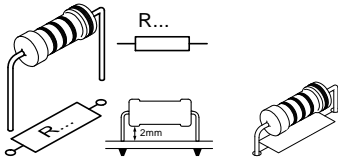

- R77 : 270 (2 - 7 - 1 - B)
- R78 : 10K (1 - 0 - 3 - B)
- R79 : 10K (1 - 0 - 3 - B)
- R80 : 15K (1 - 5 - 3 - B)
- R81 : 680K (6 - 8 - 4 - B)
- R82 : 15K (1 - 5 - 3 - B)
- R83 : 47K (4 - 7 - 3 - B)
- R84 : 47K (4 - 7 - 3 - B)
- R85 : 390K (3 - 9 - 4 - B)
- R86 : 47K (4 - 7 - 3 - B)
- R87 : 47K (4 - 7 - 3 - B)
- R88 : 390K (3 - 9 - 4 - B)
- R89 : 180 (1 - 8 - 1 - B)
- R90 : 180 (1 - 8 - 1 - B)
- R91 : 180 (1 - 8 - 1 - B)
- R92 : 180 (1 - 8 - 1 - B)
- R93 : 180 (1 - 8 - 1 - B)
- R94 : 180 (1 - 8 - 1 - B)
- R95 : 180 (1 - 8 - 1 - B)
- R96 : 180 (1 - 8 - 1 - B)
- R97 : 10 (1 - 0 - 0 - B)
- R98 : 10 (1 - 0 - 0 - B)
- R99 : 10 (1 - 0 - 0 - B)
- R100 : 10 (1 - 0 - 0 - B)
- R101 : 10 (1 - 0 - 0 - B)
- R102 : 10 (1 - 0 - 0 - B)
- R103 : 10 (1 - 0 - 0 - B)
- R104 : 10 (1 - 0 - 0 - B)

**9. LEDs. Watch the polarity!**

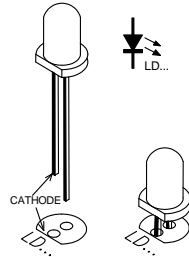

- LD1 : 5mm Red blinking
- LD2 : 3mm Bicolour

**Carefully check the assembly of this LED :**

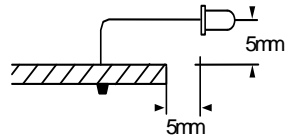
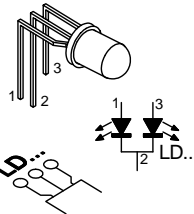

- LD3 : 3mm RED
- LD4 : 3mm RED
- LD5 : 3mm RED
- LD6 : 3mm RED
- LD7 : 3mm GREEN
- LD8 : 3mm GREEN
- LD9 : 3mm RED
- LD10 : 3mm RED
- LD11 : 3mm RED
- LD12 : 3mm RED

**10. IC socket. Watch the position of the notch!**

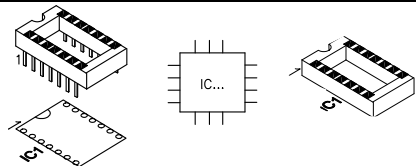

- IC1 : 18p

### 11. REED relays. Check the position of the notch!

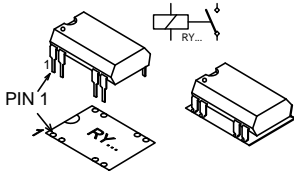

- RY1 : VR05R121
- RY2 : VR05R121

### 12. Resistors trimmers (vertical type)

- RV1 : 100K
- RV2 : 100K
- RV3 : 100K
- RV4 : 100K
- RV5 : 100K
- RV6 : 100K
- RV7 : 100K
- RV8 : 100K

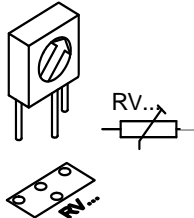

### 13. Transistors

- T1 : BC547C
- T2 : BC547C
- T3 : BC547C
- T4 : BC516

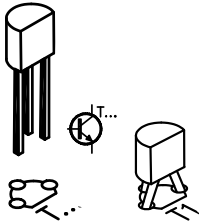

### 14. 5W resistors

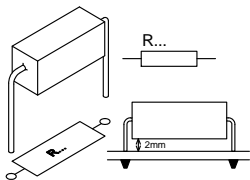

**REMARK:** You will have two 8.2 Ohm 5W resistors left over for later use.

- R105 : 15
- R106 : 15
- R107 : 15
- R108 : 15

### 15. DIP switches

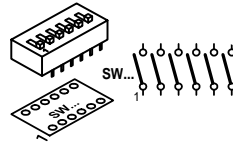

Check that switch 1 corresponds to pin 1.

- SW2 : DS-4P
- SW3 : DS-4P

### 16. Capacitors

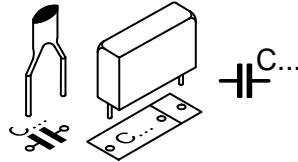

Check the minimum voltage !

- C3 : 100p/400V
- C4 : 100p/400V
- C5 : 22n/630V (0.022)
- C6 : 22n/630V (0.022)
- C7 : 470n (0.47, 474)
- C8 : 2n2 (222, 2200)
- C9 : 22n/630V (0.022)
- C10 : 100p/400V
- C11 : 22n/630V (0.022)
- C12 : 22n/630V (0.022)
- C13 : 22n/630V (0.022)
- C14 : 22n/630V (0.022)
- C15 : 22n/630V (0.022)
- C16 : 2n2 (222, 2200)
- C17 : 470n (0.47, 474)
- C18 : 100p/400V (101)
- C19 : 22n/630V (0.022)
- C20 : 22n/630V (0.022)
- C21 : 22n/630V (0.022)
- C22 : 22n/630V (0.022)

### 17. Electrolytic capacitors (check the polarity)

- C23 : 4μ7
- C24 : 100μF / 25V
- C25 : 470μF / 25V
- C26 : 470μF / 25V
- C27 : 470μF / 25V
- C28 : 470μF / 25V
- C29 : 47μF / 100V
- C30 : 100μF / 100V
- C31 : 47μF / 100V
- C32 : 47μF / 25V
- C33 : 47μF / 25V
- C34 : 100μF / 25V

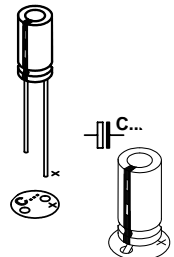

### 18. PCB connectors

☞ With the holes facing the PCB edge !

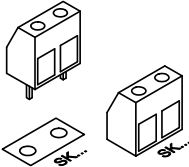

- SK3 : 2p
- SK4 : 2p

- SK9 : 2p
- SK10 : 2p
- SK11 : 2p
- SK12 : 2p
- SK13 : 2p
- SK14 : 2p
- SK15 : 2p
- SK16 : 2p

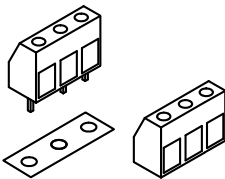

- SK5 : 3p
- SK6 : 3p
- SK7 : 3p
- SK8 : 3p

### 19. Valve sockets

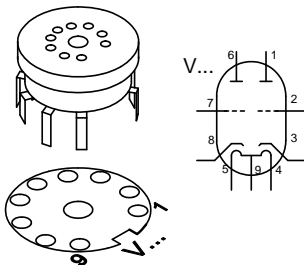

☞ Mount them square against the PCB!

- V9 : B9A
- V10 : B9A
- V11 : B9A

### 20. Power relays

☞ The various relays have leads that correspond to the printing on the PCB:

- RY3 : VR5V122C

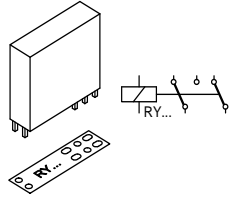

- RY4 : VR10V121C
- RY5 : VR10V121C

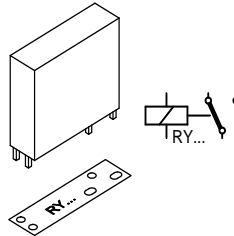

### 21. Fuse holder + fuse

- F1

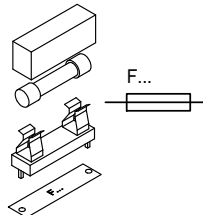

- ☞ Insert a 5A fuse for 115V
- ☞ Insert a 2.5A fuse for 230V

Fit the protective cap to the fuse holder.

### 22. Transformer

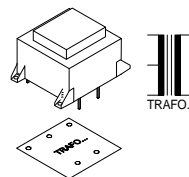

- TR1 : 12VAC

### 23. Electrolytic capacitors (check the polarity)

☞ Generally these capacitors are from the snap-in type and cannot be mounted incorrectly.

- C35 : 22 $\mu$ F/350V
- C36 : 22 $\mu$ F/350V
- C37 : 100 $\mu$ F/400V
- C38 : 100 $\mu$ F/400V
- C39 : 220 $\mu$ F/450V
- C40 : 220 $\mu$ F/450V
- C41 : 220 $\mu$ F/450V
- C42 : 220 $\mu$ F/450V

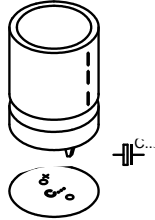

### 24. Switch

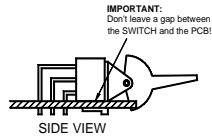
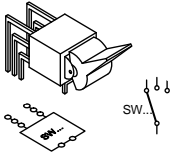

☞ Mount him as square as possible against the PCB, also solder the metal support.

- SW1 : 3P ON-ON-ON

### 25. IC. Watch the position of the notch!

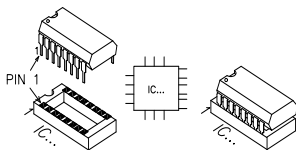

- IC1 : LM3914

### 26. 6.3V Valve wiring

Wiring for the 8 tube sockets V1 to V8. Use twisted brown wire for each one. For safety, it is advisable to check with an ohmmeter that the two 6.3V terminals are not short circuited.

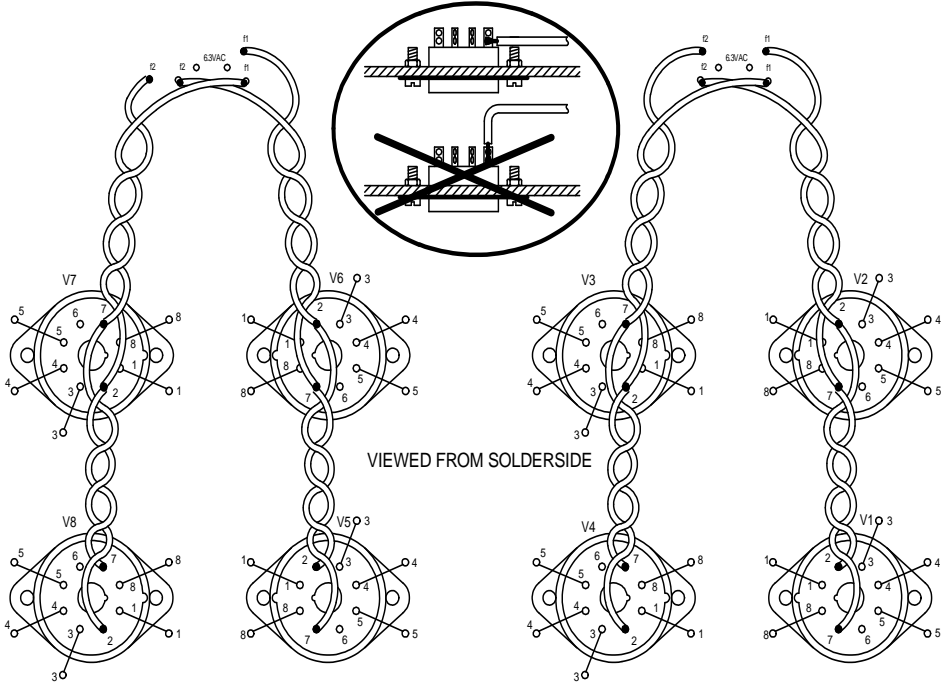

**Again thoroughly check all the components for miss mounting (polarity!) , including soldering errors !!**

## 27. Assembly into the unit

Mount the cage nuts into the square holes concerned, from the inside to the outside, (with the nut along the inside). These nuts are used to fasten the covers down, and there are 7 of them in the cabinet base.

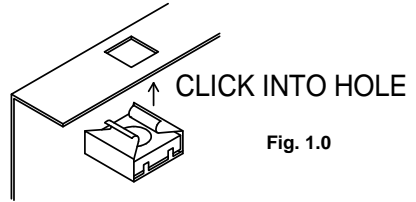

Fig. 1.0

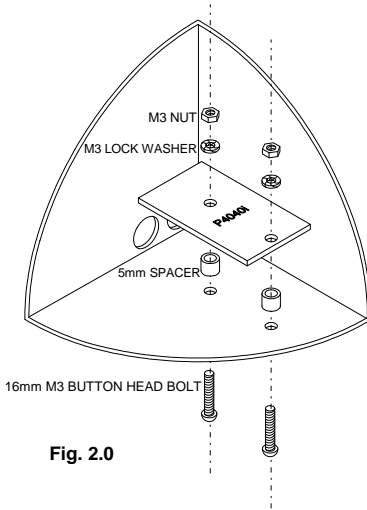

Fig. 2.0

Mount the input PCB on the right-hand side of the housing as shown in the figure. It is possible that a masking sticker from the cabinet will have to be removed, so that one of the supporting bushes can make contact with the cabinet.

Mount the chrome feet at the four corners of the cabinet using an M4 bolt. A piece of felt can be stuck under each foot.

### **Mount the loudspeaker terminals (repeat twice):**

Mount the three loudspeaker terminals on the triangular PCB plate (see figure), the connecting eyes should not be used.

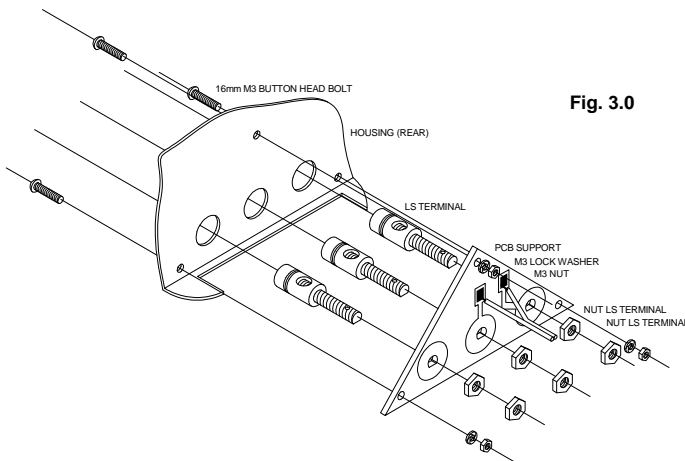

Fig. 3.0

**Check that the solder side of the PCB, is along the side of the nuts.**

- Solder a 35 cm length of yellow wire to the 4 Ohm connection (YEL).
- Solder a 35 cm length of red wire to the 0 connection (RED).

**HINT:** In order to tighten the nuts well, immobilise the loudspeaker terminal by inserting a screwdriver through the hole for the loudspeaker lead.

- Fit the unit onto the housing with three black Allen bolts, fix with a shakeproof washer and nut.

**IMPORTANT:** The loudspeaker terminals must NOT touch the metal cabinet anywhere.

- Mount the mains voltage connector to the housing using two black Allen bolts.
- Solder a 12 cm length of blue wire to the N terminal of the mains connector.
- Solder a 12 cm length of brown wire to the L terminal of the mains connector.
- Solder a 20 cm length of yellow/green earth wire and a 12 cm length to the middle terminal of the mains connector.

- Slide a 1.5 cm length of insulating heat shrink sleeve over each terminal all the way up the connector. This can be shrunken by hot air (e.g. with a hair dryer).

**IMPORTANT:** Stick a piece of insulating foil on the connector, see figure 4.0. This will later be used to prevent the connector piercing through the transformer.

Also stick a piece of insulating foil on the inside edge of the cabinet above each place where a transformer has to be put (see fig. 6).

**ADHESIVE PROTECTION FOIL**

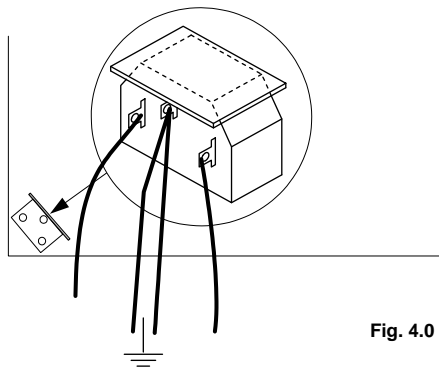

Fig. 4.0

**Mount the ring core transformers:**

- Stick a adhesive foot to the base of the cabinet, in the middle where each transformer has to be put.

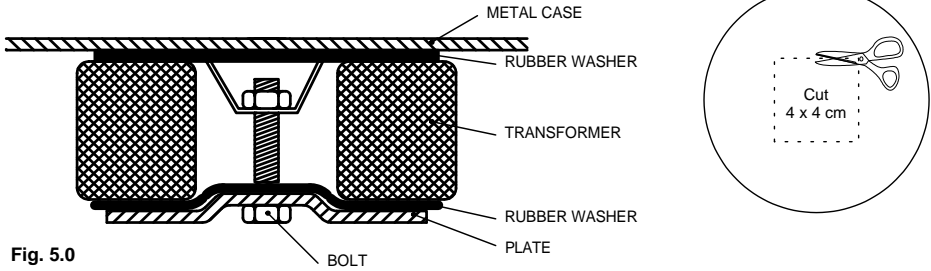

Fig. 5.0

- Mount an output transformer on the left-hand side of the housing, see figure 6.0.

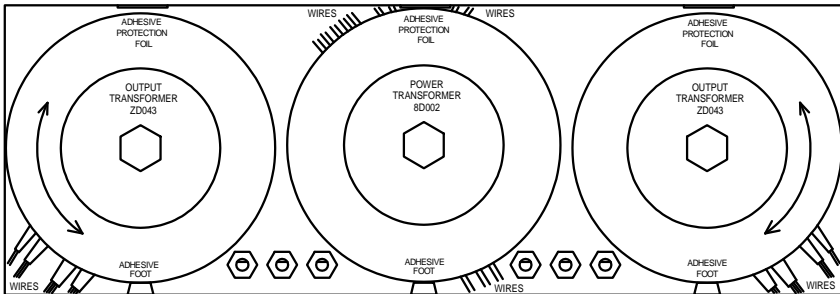

Fig. 6.0



Check the position of the leads.

- Turn over the housing and solder the transformer leads to the output terminals, see figure 7.0.

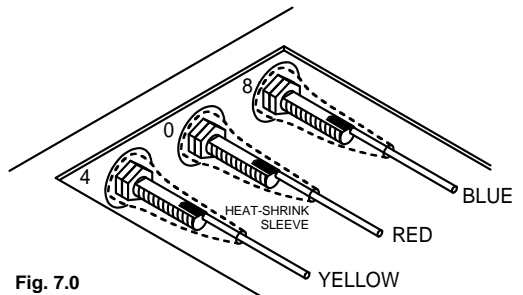

Fig. 7.0



Do not forget to insert a 3 cm length of insulating heat shrink sleeve over the wires:

- ☉ Solder the double yellow wire to the 4 Ohm loudspeaker terminal.
- ☉ Solder the red wire to the 0 loudspeaker terminal.
- ☉ Solder the blue wire to the 8 Ohm loudspeaker terminal.



**IMPORTANT:** Heat the terminals up until the solder melts easily. Then slide the insulating heat shrink sleeve over the leads.



- Twist the previously soldered red and yellow wires together and fit them as shown in the figure, the cable ties supplied can also be used.

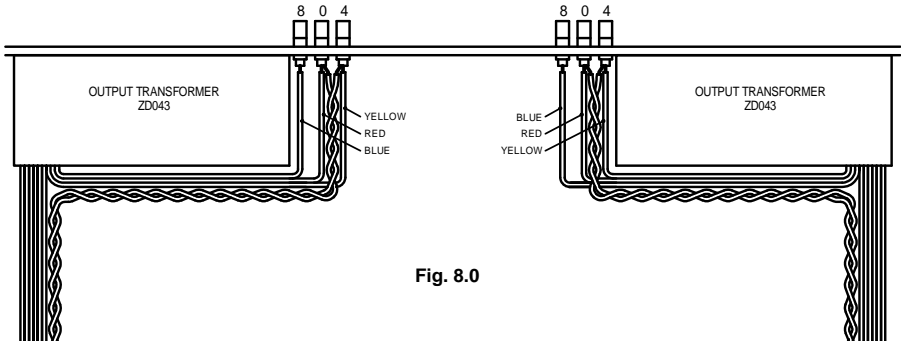



Fig. 8.0

- Mount the supply transformer in the middle of the cabinet. Ensure that the leads are positioned as shown in the figure 6. The thick grey and green wires must be at the highest point.
- Mount an output transformer along the right-hand side of the housing, see figure 6. Check the position of the wires.
- Solder the transformer leads to the output terminals, see figure 7. Do not forget to slide a 3 cm length of insulating heat shrink sleeve over the wires:
  - Solder the double yellow wire to the 4 Ohm loudspeaker terminal.
  - Solder the red wire to the 0 loudspeaker terminal.
  - Solder the blue wire to the 8 Ohm loudspeaker terminal.

👉 **IMPORTANT:** Heat the terminals until the solder melts easily. Then slide the insulating heat shrink sleeve over the leads.

 **IMPORTANT:** Ensure that the transformers do not touch any metal parts such as the loudspeaker terminals or the input connector.

## 28. Assembly and wiring

Fit the main PCB into the housing and screw it down with the black Allen bolts along the underside. Connect the mains lead to the screw connector, MAINS, with the blue wire to the N terminal and the brown wire to the L terminal. The short earth wire is connected to the EARTH connector.

### Connection of the transformers:



**IMPORTANT: The connector leads of the transformer may not be shortened. If there is more than one wire in an insulating sleeve, then they MUST be soldered together, and only then connected to the screw connector.**

- Connect the left-hand output transformer to the left-hand connector, SK7, and the right-hand output transformer to the right-hand connector, SK8.
- ☞ The twisted yellow and red wires must also be connected to the proper connector. See fig. 9

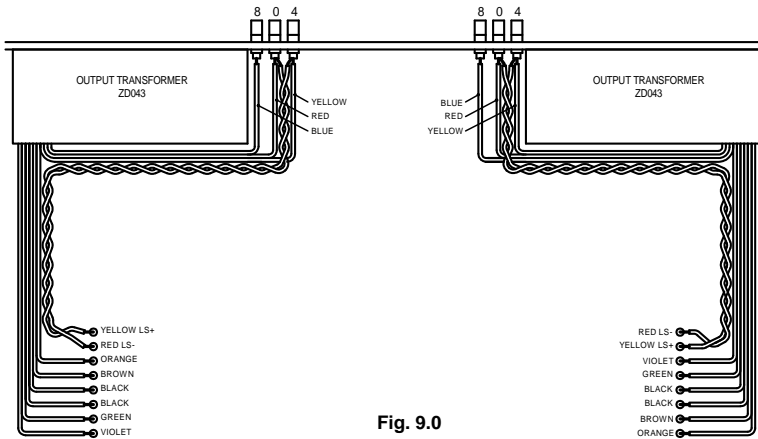

Fig. 9.0

- Connect the leads of the supply transformer to the screw connector, SK6.

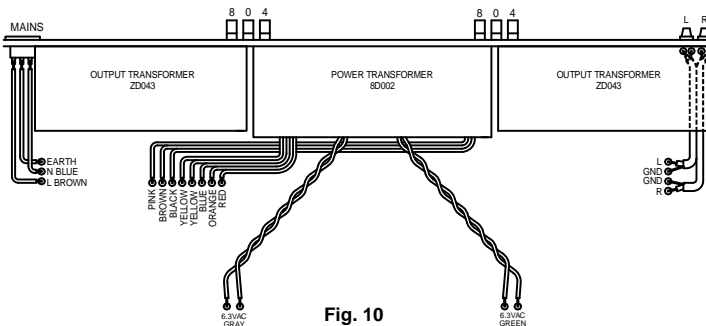

Fig. 10

- The thick grey wires may be twisted and connected the 6.3V connection (SK3) of the left-hand amplifier.
- The thick green wires should be connected in the same way to the 6.3V connection of the right-hand amplifier PCB.
- Connect the screened cable from the input PCB to the L connection (left channel) and the screen to the GND connection. Do the same for the right channel, R.

**29. Final inspection**



**ATTENTION: THERE ARE VOLTAGES OF MORE THAN 400V AT MANY POINTS ON THE PCB. Ensure that suitable insulated measuring leads are used. Ensure that no children are in the vicinity.**

- Switch the mains voltage switch to OFF, ie. fully down.
- Connect the mains connector via a lead to a mains outlet. The plug may have to be changed for your country. In that case, cut off the plug from the lead, and connect an appropriate plug for your country.
- Connect the blue wire to the N connector of the mains, the brown wire to the L connector and the yellow/green wire to the earth.
- When connected to the mains, the red LED at the front should light up.
- Switch the mains switch to ON ie. fully up. The LED at the front should flicker green/red while the amplifier is warming up. After approx. one minute, the green LED will be continuously lit, you will also hear a relay enlignise.

**Check the following voltages with a volt meter:**

Approx. 6.3 VAC on the terminals marked 6.3 VAC (SK3 and SK4) on each amplifier half. 6.3V should also be found at connectors 2 and 7 of the tube sockets, V1 to V8.

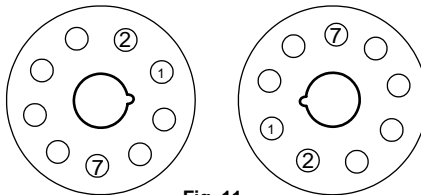

Fig. 11



**FIRST SWITCH OFF THE MAINS VOLTAGE AND REMOVE THE MAINS CORD FROM THE SOCKET. WAIT FOR A COUPLE OF MINUTES UNTIL THE HIGH VOLTAGES ON THE SUPPLY ELCOS HAVE DISSAPEARED.**

**Fit the small tubes:**

- **V9** and **V10**, type ECC83 or 12AX7, CV492.
- **V11**, type ECC82 or 12AU7, CV491.
- Again connect the amplifier to the mains and set the mains switch to ON (fully up).
  - ☞ Wait until the green LED is lit continuously.
- Now check the voltages on the PCB, measure the voltages with respect to earth. Earth can be taken from lead **J26** (next to the mains switch). Measure the voltages at the points indicated on the PCB.

☞ **NOTE:** The measured voltages may differ depending on the tolerances of the mains connected. Voltages of 0.4V cannot yet be checked.

### 30. Setting up

- Switch off the mains voltage.
- Turn all trimmer potentiometers, RV1 to RV8, fully anticlockwise.
- Mount the 8 tubes, V1 to V8, type EL34 (or C6A7, CV1741) into their sockets (check the position of the notch).



**IMPORTANT: Connect an 8.2 Ohm 5W resistor between the output terminals (0 and 8 Ohm) of both channels. The output of a tube amplifier must always be loaded. Make sure that there is a good contact with the loudspeaker terminals, the connections of the resistors may have to be thickened a little with solder.**

#### Standby current adjustment

No measuring equipment is needed for the following adjustment, the standby or bias current of each tube can be seen from the LED scale on the front. The individual tube to be checked can be selected using the small DIP switches. RV1 corresponds to V1, RV2 to V2, etc.



**ATTENTION: The following adjustment is a reference for the bias current of the power tubes. Be very careful in setting them. Also respect the order of adjustment. No signal may be connected to the input.**

Set all 8 DIP switches to the OFF position (up). Each switch has an associated tube, never set more than one switch ON (down) otherwise you will get an incorrect reading of the LED scale. Switch the mains voltage on and wait until the green LED is lit continuously.

#### Adjustment of the left-hand channel:

- Switch the first switch of SW2 (left-hand DIP switch) ON (down).
- Carefully adjust RV1 until the second or third LED lights up (LD4 or LD5).
- Switch OFF the first switch (up).
- Switch ON the second switch (down).
- Carefully adjust RV2 until the second or third LED lights up.

Complete the adjustment for all tubes of the left-hand channel.

#### Adjustment of the right-hand channel:

- Ensure that all switches of the left-hand channel are OFF (up).
- Switch the first switch of SW3 (right DIP switch) ON (down).
- Carefully adjust RV5 until the second or third LED lights up (LD4 or LD5). Switch OFF the first switch (up).
- Switch ON the second switch (down).
- Carefully adjust RV6 until the second or third LED lights up.

Complete the adjustment for all tubes of the right-hand channel.

Now wait for around 10 minutes.

Repeat the complete adjustment but adjust until one of the two **green** LEDs lights up. After adjusting all tubes, the voltages of around 0.4V can be checked.

### 31. Test

The amplifier can now be connected to loudspeakers of 8 or 4 Ohms, the common connection is in the middle.

**IMPORTANT**

If 8 Ohm loudspeakers have been connected, then first check that not too much hum can be heard in the loudspeakers, which is why a preamplifier should not yet be connected. Should too much hum be audible, then the output transformer of the channel concerned should be turned a little clockwise or anti-clockwise until the hum weakens. This operation has no effect on the 4 Ohm connection.



Note that the amplifier is under voltage. Be careful when turning the transformer because if any of the leads come away the transformer will be damaged. It is best to place a small loudspeaker close to the amplifier such that you can turn and listen for the best result.

Now a preamplifier can be connected and the unit can be tested with music.

### 32. Final assembly of the cabinet

Before fitting the covers, check the supply and amplifier PCBs to see that no components have been mounted too high.

- Mount the cover on the base (set the cabinet on its side) using black Allen bolts.
- Make a loop of the three earth connections in the cabinet, via the spade plugs and the length of loose earthing wire, the last lead goes to the rear mirror.

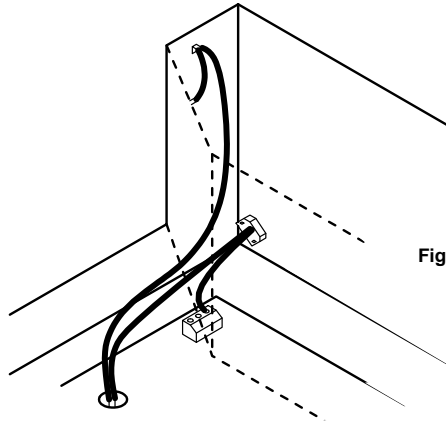
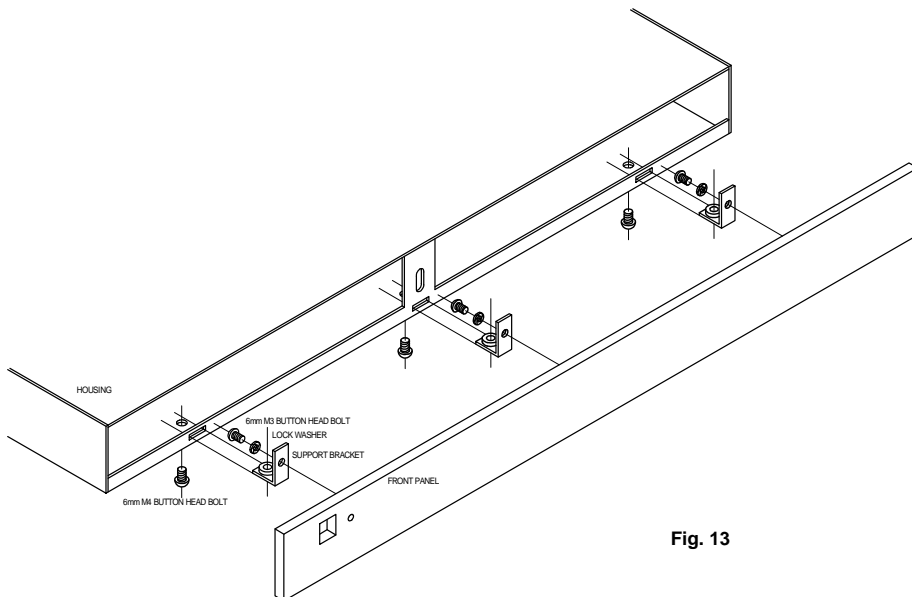

Fig. 12

- Mount the cage nuts in the rear mirror (be careful of scratches), the groove for the earth lead goes upwards, then the nuts of the cage nuts should be below.
- Attach the cover plate for the tubes to the rear mirror (do not yet tighten the bolts). When using a black cover, a masking sticker may have to be removed from around one of the holes, such that plates can make an electrical contact.
- Mount the cover plate and rear mirror on the cabinet and fasten them temporarily with Allen bolts.

- The cabinet can now be completed by first fitting the covers for the supply transformers.
- Mount the front panel to the cabinet, use the support brackets supplied, together with M3 and M4 Allen bolts. Check the position of the switch and the LED (see figure 13).

**Fig. 13**

- If it all fits together well, then all bolts can be fully tightened.

**33. Usage**



**WARNINGS.**

THIS UNIT GETS HOT, KEEP OUT OF REACH AND AWAY FROM CHILDREN.  
 CHECK THAT THE MAINS VOLTAGE CORRESPONDS TO THAT OF THE UNIT.  
 BEFORE OPENING THE UNIT, THE MAINS CORD MUST BE REMOVED IN ORDER TO  
 AVOID ELECTRIC SHOCKS.

It is normal for the tubes and cabinet to get very hot, so place the amplifier in a well ventilated area, certainly not in a closed cabinet or rack.

We advise to check the standby current adjustment once a year, certainly if the end tubes are new. This can easily be done by removing the front panel.

If the amplifier is not used for a short period of time, then set it to standby by putting the mains switch in the middle position.

**34. Troubleshooting**

*No high voltage.*

- Check the transformer wiring.
- Check the fuses.

*Irregular crackling in the loudspeaker.*

- Replace R88 or R85 of the channel concerned.

*A continuous buzzing in the loudspeaker (continuous oscillation of the amplifier) or crackling in bass peaks.*

- When using a piezo tweeter, a 10 Ohm resistor must be placed in series with the tweeter.
- Increase R65 and R68 in value e.g. 1k or 1K5 (the input sensitivity will then be somewhat higher).

THE ABOVE ADJUSTMENTS SHOULD NOT BE DONE IN ANTICIPATION, ONLY IN THE EVENT OF PROBLEMS AND AFTER HAVING THOROUGHLY CHECKED ALL COMPONENTS, CABLING AND SOLDERING.

☞ **NOTES:** As tubes are very sensitive to shocks, do NOT move the unit when the tubes are hot. Should a tube nevertheless fail, then this can be seen by the sudden bright red glow of the lamp. In the event of the lamp discharging, then the associated anode resistance of 10 Ohm will almost certainly be defective, also check the 220 Ohm resistors, R63, R64, R66 and R67.



**ATTENTION: Should the amplifier not work, just send it to us so that we can check it. Please only send the MAIN PCB !.**

If you decide to send the complete unit, you MUST order a special protective shipping box (order code DM4040) from you distributor. If not then the unit will surely be damaged during transport and it will suffer damage beyond repair.

Velleman Kit can never be hold responsible for damage during transport!

Happy listening.







37. Diagram (left channel)

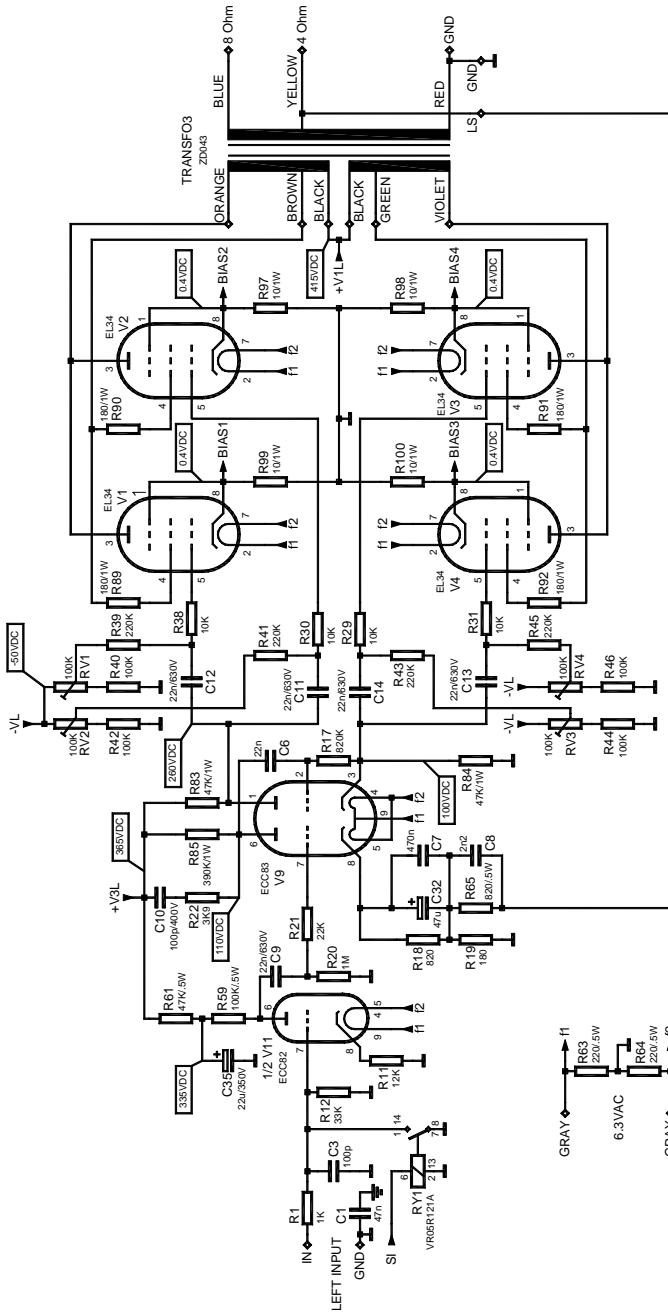





VELLEMAN NV  
Legen Heirweg 33, B-9890 GAVERE  
Belgium (Europe)

